

Air 10s

Commander for wireless flash shooting
Canon / Nikon / Sony

INSTRUCTION MANUAL



Changes or modifications not expressly approved by the party responsible for compliance could void the user's authority to operate the equipment.

This device complies with Part 15 of the FCC Rules. Operation is subject to the following two conditions: (1) this device may not cause harmful interference, and (2) this device must accept any interference received, including interference that may cause undesired operation.

Thank you for purchasing a Nissin product

Before using this commander unit, please read this instruction manual and refer to the manual of camera owner carefully to get a better understanding of the proper operation to enjoy flash photography.

The commander Nissin Air 10s (Canon/ Nikon/ Sony) is an advanced commander for wireless flash shooting. It controls up to 8 groups of NAS (Nissin Air System) flash (Canon/ Nikon/ Sony) that have a wireless multiple flash shooting function using NAS (radio transmission). Please note that Nissin Air 10s (Canon/ Nikon/ Sony) are not usable with other branded cameras for TTL operation.

Compatible cameras

Please refer to Nissin's compatibility chart shown here:
<http://www.nissindigital.com/download.html>



Nissin Air System (NAS) is a Nissin wirelessly remote control flash light system, designed by Nissin. It consists of a Nissin radio commander (NAS commander) and the Nissin wireless flash (NAS flash) and Nissin radio receiver (NAS receiver) as remote slave units.

- Insert Air 10s on the camera hot shoe as a NAS commander.
- The signal of Air 10s is transmitted by using 2.4 GHz transmission.
- Transmission distance is approx. 100m (330 ft.)
(Metal/ Wire/ Wall/ another 2.4 GHz radio frequency may cause a reduction in the NAS transmission distance)

SAFETY INSTRUCTIONS

These safety instructions refer to important information on how to use this product safely and properly. Please read the following instructions before using the product.



CAUTIONS

This sign refers to conditions which may cause damage or defect.

- Do not touch the inside parts from the opening when the unit was dropped or broken.
- Place the batteries correctly in position. Placing the batteries in wrong polarity may cause leakage, exothermic heat or explosion.
- Do not leave or store the commander unit in the temperature over 40°C/ 104°F, such as in the automobile.
- The commander unit is not water resistance. Keep the unit away from rain, snow and humidity.
- Do not use benzene, thinner or other alcoholic agents to clean the unit.
- Do not use this commander unit with cameras which are not recommended in the compatibility list at official website, otherwise it may damage the camera's circuitry^(*).
- Remove the batteries when not in use for a longer period of time.
- Do not use the Nissin Air 10s to pick up whole camera system when it installed on your camera. To pick up the whole camera system, you should hold the handle of camera body or the lens..

(*) Please refer Nissin's compatibility chart shown here:

<http://www.nissindigital.com/download.html>

Names of the Components

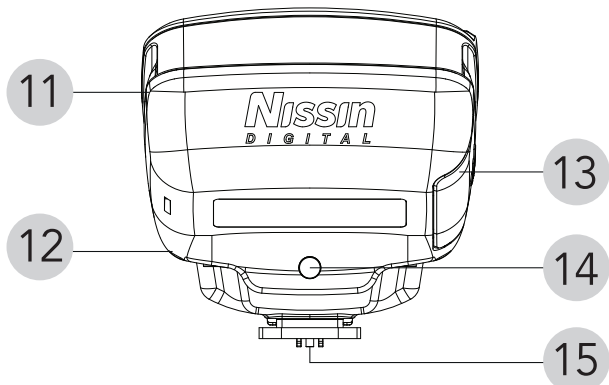
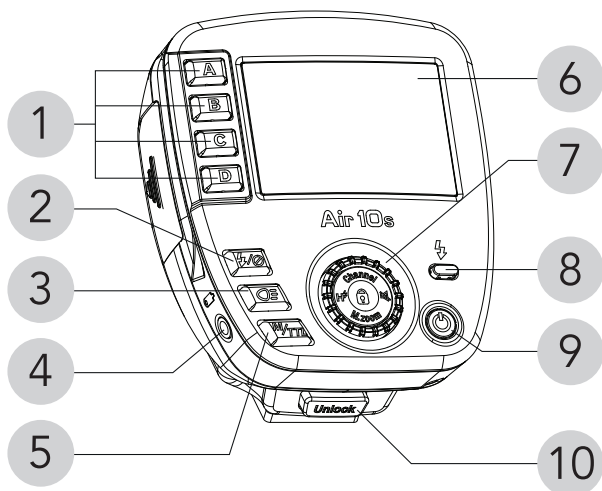

- | | |
|---|--|
| 1 Group selection button | 8 Pilot button (Test flash button) |
| 2 Group on/off button | 9 Power On/Off button |
| 3 Modeling light button
(Basic/Advanced Groups button) | 10 Unlock button |
| 4 Shutter cable socket (2.5mm) | 11 Micro SD card slot
(for firmware update) |
| 5 M/TTL Mode Button | 12 Strap hole ⁽²⁾ (strap is not included) |
| 6 LCD panel | 13 Battery compartment door |
| 7 Select dial with buttons
Channel button
HSS button
Buzzer button
M.Zoom button
Panel Lock/Unlock button (hold 1sec.) | 14 AF-assist light ⁽¹⁾ |
| | 15 Hotshoe contacts |

(1) The AF-assist lamp supports digital system cameras measuring autofocus in the center of the image field only. It does not support other camera brands, other types of Canon, Nikon and Sony cameras or camera models without our compatibility test.

(2) The strap hole made for carrying the Air 10s around the neck.

Before starting wireless flash shooting.

Inserting batteries

1. Open the battery compartment door and insert 2 x size AAA batteries as shown in the picture.
2. Make sure the + and - battery contacts are correctly inserted in the battery compartment.
3. Close the battery compartment door and slide it back in place.

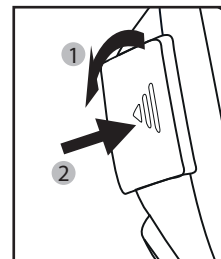
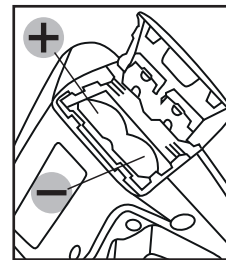
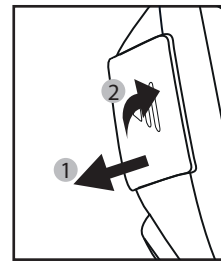

(* Air 10s has an energy saving power off function

To save battery energy, the screen of Air 10s display dims in about 30 seconds and turns off in about 2 minutes automatically after the setting job is terminated. While Air 10s is in the stand-by mode, a blinking signal will be shown on the Pilot Button. To turn on Air 10s again, press any button on the Commander. In case of not in use for over 60 minutes, Air 10s will be turned off completely. To turn on Air 10s again, press Power button on the Commander.

CAUTIONS

It is recommended to use 2 batteries of the same brand and type, and replace them all at the same time.

Wrong insertion of each battery would not make electric contact.

Default Setting reset

**Press power on to activate Nissin Air 10s,
hold the Pilot button for 5 seconds to reset to factory default setting**

Default setting:

1. TTL mode: +/- 0EV
2. M Manual mode: 1/256
3. Zoom setting: Manual, 24mm
4. Channel Setting: no. 2
5. HSS mode: off
6. Buzzer: off
7. Group Mode: Basic Groups
8. Group status: all on

Basic Operation

Mounting Air 10s on the camera

1. Turn off Air 10s.
2. Insert the mounting foot of Air 10s into the hotshoe of the camera.
3. Make sure that the mounting foot will lock (with a “click”) when it has been inserted completely.

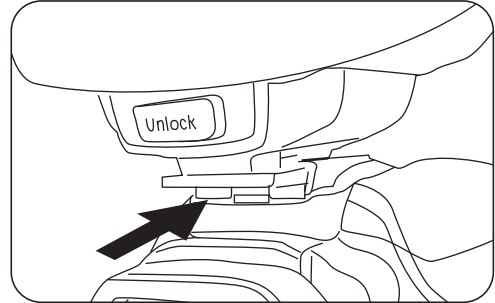

Removing Air 10s from the camera

1. Turn off Air 10s.
2. Hold the unlock button and slide the mounting foot of Air 10s off the hotshoe of camera.

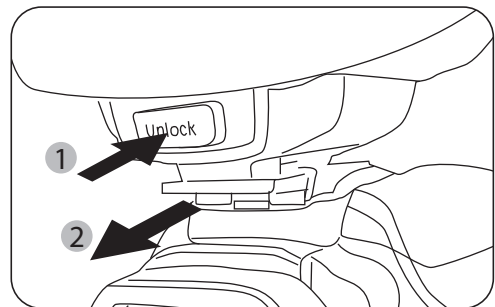

CAUTIONS

Do not use the Air 10s as a holder to pick up the whole camera system.



Wireless Flash Shooting

Pairing Setting

To perform wireless shooting, set the Nissin Air 10s commander and NAS slave unit with the following procedure. After pairing is completed, both of them will memorize the data and there will be no need to pair again after the units are switched on and off.



For Sony Camera

Before using Commander Air 10s, please install Air 10s on camera and change the Flash mode to "WL" in camera menu.

Step 1: Switch all flash and Commander off

Nissin flash Di700A

1. Hold the "Set" and Power "ON/OFF" buttons for 3 seconds at the same time.
2. "Beep" sound persists until the Pairing signal from commander is received.
When the "beep" sound stops, the pairing is complete.
3. Nissin Di700A will automatically be changed to wireless slave mode after Pairing completed.

Nissin flash i60A

1. Switch on your Nissin i60A, hold the "Channel" button for 2 seconds to check and make sure the channel setting in the display is in the "A" Auto channel mode.
2. Turn off the Nissin i60A.
3. Hold the Panel Lock key and the "On & Off" button of Nissin i60A at the same time for 3 seconds..
4. "Beep" sound persists until the Pairing signal from commander is received.
When the "beep" sound stops, the pairing is complete.

Nissin flash MG10

1. Rotate the "Ch" channel dial to "Auto" auto channel mode.
2. Hold the "Open" button and the power button for 3 seconds.
3. "Beep" sound persists until the Pairing signal from commander is received.
When the "beep" sound stops, the pairing is complete.

Nissin Air R Receiver

1. Rotate the "Ch" channel dial to "Auto" auto channel mode.
2. Hold the power button for 3 seconds
3. "Beep" sound persists until the Pairing signal from commander is received.
When the "beep" sound stops, the pairing is complete.



Wireless Flash Shooting

Step 2: Pairing on Nissin Air 10s commander

1. Start the Pairing mode of all slave units and the "beep" sound are constantly heard.
2. Turn off Nissin Air 10s then hold the Panel Lock key and the power "On/Off" button for 3 seconds at the same time.
The Pilot LED will blink about ten seconds (the display will not light up while pairing).
When Nissin Air 10s Pairing mode has stopped, slave units around the commander will also complete the pairing process one by one, and stop the "beep" sound.
3. To check the pairing between Nissin Air 10s and slave units, press the "Pilot LED" button on Nissin Air 10s for test and let NAS flash and the flash on NAS receiver emit a weak output test flash.

(*) Nissin Di700A, i60A flash and Nissin Air R receiver do not support the Channel 1 in Nissin Air 10s. Please use Channel 2 to 8 to pair with those 3 NAS slave unit models.

The default channel setting is no. 2.

If you want to change this setting then press the channel button for 2 second.

Press channel button 2 second to exit setting.

	Air1	Air 10s
i60A / Di700A / Air R	Ch.1 - 8	Ch.2 - 8
MG10	Ch.2 - 8	Ch.1 - 8

CAUTIONS

If strobes still have "beep" sound constantly after finishing the pairing process, this means the pairing process is not complete. Please move your Air 10s towards the Beeping strobes, then turn off the Air 10s and re-do the pairing process by holding Panel Lock key and the "On/Off" button again for 3 seconds.





Open Mode (only works with MG10)

The NAS system is using an independent identity (ID) function to access strobes, the NAS strobes will not be affected by other commanders whenever they are using the same channel in the same location. A slave unit of Nissin flash or Nissin receiver can only be controlled by one and only one NAS commander with pairing in default setting.

Air 10s offers “Open Mode” ,a new function (only works with MG10), on the pairing setting. Open Mode can let two or more camera using same set MG10 in one place.

Open Mode Setting

1. Hold the  button of Nissin Air 10s for 1 seconds,
 lights up on lower left corner means Open Mode is on.
Now hold the  for 1 seconds again to turn off.



Basic Groups and Advanced groups

There are basic groups and advance groups for controlling the Nissin Air10s. They allow the user to pair an unlimited amount of slave units. They mainly divided into two kinds of groups:

Basic Group

A B C D

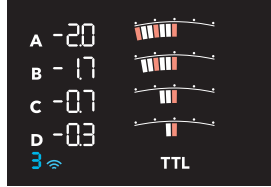

TTL mode

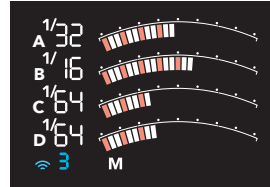

M mode

Advance Group

À B Ć D

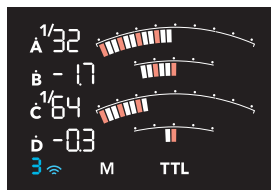

M/TTL mode

Basic groups and advance groups can be use at the same time for different strobes. Example:

Use the i60A in basic group A on manual, use two MG10 in advance group À & Ć in TTL and manual mode.

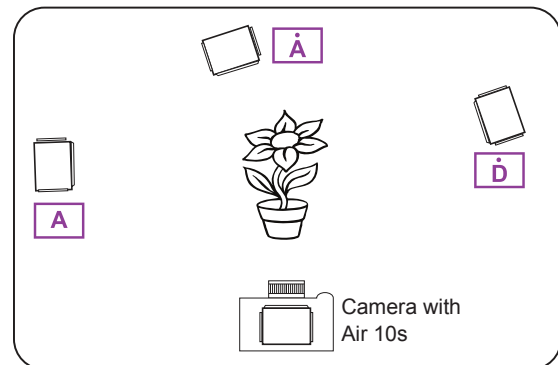













Group Setting

Air 10s, provides individual control of 4 groups (strokes), you can set these 4 groups in different settings. Before shooting, you have to set each strokes to be one of these 4 groups.

Nissin Di700A Flash

1. Power on Nissin Di700A and switch to  wireless slave mode, press "Set" several times until the  /  /  (Group mode in the display), then turn the  to change the group number.
2. Press the  key to confirm the new setting.





Nissin i60A Flash

1. Use  Mode Dial to change group  /  / .

Nissin MG10 Flash

1. Use  Mode Dial to change group  /  /  /  /  /  /  / .

Nissin Air R Receiver

1. Use  Mode Dial to change group  /  / .



Group On/off Setting

In testing or changing the flash effect of different slave units group, you can turn on or turn off any group.

Nissin Air 10s Commander

1. Press the  Group Selection button on Nissin Air 10s.

While the selected group is blinking in the display, press the “Group On/Off” button.

When the group is switched on, the exposure setting value and exposure bar

will be appeared on the right side of the group. When the group is switched off, only "----" is shown.

2. Press the “Group Selection” button when finish setting.

For example :

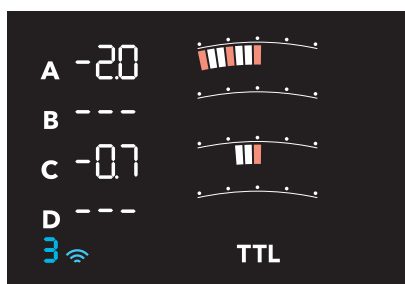

A & C: on, B & D: off

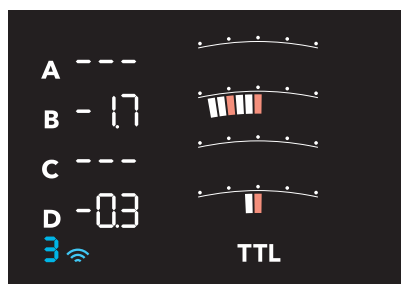
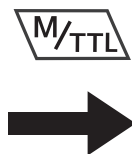

A & C: off, B & D: on



Flash power control

When the NAS flash is set to the wireless mode, all exposure setting functions will be controlled by the NAS commander.

TTL and M exposure mode switch

In Basic groups mode: Press the  button.



In Advanced groups mode:

To set different exposure in each group:

1. Press the Group Selection button. When the letter “A” blinks, press M / TTL mode button to change the exposure (the same procedure works with groups B, C, and D).
2. After completing the exposure setting, press the Group Selection button again to stop the blinking.

Flash Exposure Control

TTL flash exposure compensation

1. Press the Group Selection button, the group letters blink.
2. Rotate the Operation Dial to increase or decrease the TTL flash exposure compensation. The settings of TTL auto exposure compensation on Nissin Air 10s starts from -2EV to + 2EV and controlled by 1 / 3EV step interval.



TTL mode

In addition to the bar chart, there are a number of exposure values shown:

- Setting of 0EV shows in 0.0,
 - Setting of -2EV to -0.3EV will be displayed in -2.0 to -0.3;
 - Setting of +0.3EV to + 2EV will be displayed in 0.3 to 2.0.
3. When the exposure compensation setting is completed, press the group selection button again.

TTL memory (exposure value memory)

Switching Air 10s from TTL mode to M mode, the last flash power setting will be saved in TTL control. Flash power value will also remain unchanged in M mode.

CAUTIONS

If you do not press any group selection button which means all group letters in the display do not blink, rotate the Operation Dial to increase/ decrease the power of all groups. For example, A: 0EV, B: + 0.6EV, C: + 1EV, D: -1EV, do not select any group then turn the Operation Dial clockwise in 2 click intervals, will cause to A: + 0.6EV, B: + 1.3EV, C: 1.6EV, D: -0.3EV.

Flash Exposure Control

M manual flash mode power control

1. Press the Group Selection button, the group letter blinks.
2. Rotate the Operation Dial to increase or decrease the flash power of the group selected.
The setting of M mode on Air 10s starts from 1/256 (minimum) to 1/1 (Full), and controlled by 1/3 step intervals. The value digi displayed next to the group only shows the integer step value (*).



M mode

3. When the M mode setting is completed, press the group selection button again.

(*) The integer step values of Nissin Air 10s are

1/1, 1/2, 1/4, 1/8, 1/16, 1/32, 1/64, 1/128 and 1/256

CAUTIONS

If you do not press any group selection button which means all group letters in the display do not blink, rotate the Operation Dial to increase/ decrease the power of all groups. For example, A: 1/256, B: 1/8 + 0.6EV, C: 1/4, D: 1/2, do not select any group then rotate the Operation Dial clockwise with 2 intervals, it becomes A: 1/256 + 0.6EV, B: 1/4 + 0.3EV, C: 1/4 + 0.6EV, D: 1/2 + 0.6EV.



Zoom head setting

Nissin Air 10s offers "A" auto zoom mode and manual zoom mode.

1. Hold the **M.ZOOM** for 2 seconds.
2. Press the group selection button until the the desired letter(s) blink.
Rotate the Operation Dial to change the Zoom head position setting.
The focal length is representing the flash angle. Rotate the Operation Dial in anti-clockwise direction to decrease the value of the focal length of zoom head. Keep rotating anti-clockwise to change the "A" automatic zoom mode at the end. Rotate the Operation Dial in a clockwise direction to leave.
The "A" auto zoom mode will increase the value of the focal length value of zoom head. Coverage range supports 24mm, 28mm, 35mm, 50mm, 70mm, 85mm, 105mm, 135mm and 200mm focal length lenses.
3. Press the group selection button again after completion of the zoom setting.
Hold **M.ZOOM** for 2 seconds again when all groups zoom settings are completed.

CAUTIONS

If you do not press any group selection button, which means all group letters in the display do not blink, rotating the Operation Dial to increase or decrease the flash zoom head focal length will affect all groups; A, B, C and D.



Modeling light

Normal flashguns have a very short flash duration. In order to estimate and control the flash more efficiently, the modeling light on slave unit can be used. It is a constant light for the user to estimate and preview the light before shooting (flash emitting).





(*) Modeling light is a new feature of the NAS system.

Nissin Di700A, i60A, i40 flash and other discontinued models do not support this feature.

Turn on/off the modeling light

1. Press the Group Selection button(s), the group letter(s) blink.
2. Press  to switch the group's modeling on/off.
3. Press the Group Selection button again when setup completed.

Adjusting modeling light

1. Press  on Air 10s for 1 second to switch to the advanced groups.
2. Press  to change to M mode.
2. Press  to turn on modeling light.
3. Use the  to adjust the modeling light power.

CAUTIONS

If you do not press any group selection button, which means all group letter in the display do not blink, pressing the modeling light button will invert the modeling on/off setting of all groups. For example, A & C: On and B & D: off, press the modeling light button without selecting any group, will cause to A & C: Off, and B & D: On.



High Speed Synchronize (HSS / FP)

Flashgun supports shutter speed limitation on X-Sync (maximum speed synchronize to flash) on SLR / DSLR /Mirrorless Cameras in general. If it does not support HSS function of the camera, faster shutter speed settings than the maximum synchronize speed will block the flash gun. With faster shutter speeds than the maximum sync speed some part(s) of the image area would be shaded by the moving shutter leaves within the flash duration. As a result the image is only partially exposed by the flash light.”. HSS allows flashgun works under high speed shutter (max 1/8000s).

Air 10s HSS On & Off switch

- Method A (for Canon & Sony)
Hold **H**⚡ button for 2 seconds to turn on or off.
- Method B
 1. Insert Air 10s to Canon camera shoe.
 2. Switch on both Air 10s and Camera,
For Canon: Menu setting > External Flash setting > HSS mode in the sync setting
For Nikon: Custom setting menu > Flash > Flash sync speed > Auto FP

Exposure setting under HSS mode

The flash emitting operation in HSS mode is different from the normal flash mode. With the HSS function, users can get a faster shutter speed which will result in a lower guide number. This is equivalent to a lower flash output. The flash of HSS cannot be measured by an external light meter. When HSS is on, the exposure compensation setting of TTL mode offers the same -2EV to +2EV of basic mode. Using the power control of "M" Manual mode under HSS, the Air 10s offers 1/32 to 1/1 power range only. If power is set from 1/256 to 1/64+0.3EV, "M" manual power setting will automatically change to 1/32 in HSS mode.



Buzz (Beep sound) on strobes

All settings of strobes are controlled by the commander wirelessly after the pairing is completed. If the strobes buzzer is on, a “Beep” sound will be heard when the Strobe is charging and not ready to flash. The “Beep” sound will be heard everytime when there is any change made through the commander.

Air 10s Beep or Buzzer on & off switch

Hold  button to switch the buzzer (on strobes) on or off.

When “no buzzer” logo is displayed in LCD, it means that the beep sound is off.

When the “no buzzer” logo disappears, then the buzzer function is turned on.

Firmware update procedure

To start the firmware update procedure, you need to have:

- The computer (Windows or Mac) connected to the Internet
- A Micro SD/SDHC card (recommend 4GB-32GB) and Micro SD card reader.
- Air 10s with 2pcs of full re-charged AAA batteries.

1. Download the Firmware file(s). Click here to download firmware files:
<http://www.nissindigital.com/firmware.html>
2. Insert Micro SD/SDHC card to the card reader and connect to the computer.
3. Format Micro SD/SDHC card under FAT32 format (Please backup before format).
4. Copy all Firmware file(s) to Micro SD/SDHC card.
5. Eject the Micro SD/SDHC and remove from the card reader.
6. Insert AAA batteries into Air10s and switch on it.
7. Then switch off the Air 10s.
8. Remove the Micro SD/SDHC cover of Air 10s, insert the Micro SD/SDHC which contains the latest firmware update files into the Air 10s.
9. Switch on the Air 10s. A LED light inside the Micro SD card slot of Air 10s will blink, it will blink and the light will change orange to red and stop blinking once the update is finished.
10. The green light will emit when the firmware update procedure is completed. Remove the batteries and remove the Micro SD/SDHC.
11. Insert the batteries again and switch on the Air 10s.

How to check firmware version of Air 10s

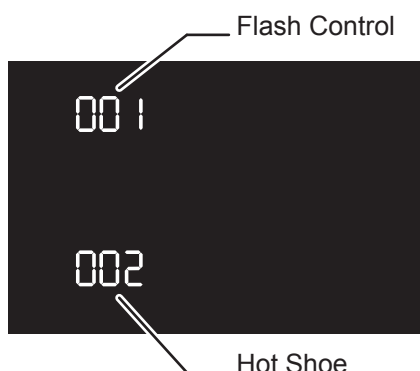

Switch on power, press and hold the Power on/off button for 5 seconds. LCD display will show 2 different firmware versions. Release the Power button about 2 seconds, firmware version page will disappear and returns to the front operation page.

Specifications

Type	Canon / Nikon / Sony
Wireless system	
Radio specifications	NAS 2.4GHz ISM band (to obtain technical standards certification)
Channel	8 channels (channel setting in Air 10s)
Flash Groups	8 groups ⁽²⁾ : A , B , C , D & Ā , B̄ , C̄ , D̄
Transmission distance	100 meters ⁽¹⁾
Remote flash control system	
Wireless flash exposure mode	TTL automatic flash exposure mode with +/- 2EV compensation and in 1 / 3EV step intervals; M manual flash output mode, offers 1/256 to 1/1 control with 1/3 step intervals
Supporting TTL Exposure control	[TTL] i-TTL (Nikon) / E-TTL II / E-TTL (Canon) [manual]/ ADI/ PTTL (Sony)
Flash sync mode	1st curtain & 2nd curtain sync., red-eye reduction HSS (up to 1 / 8000s), slow shutter sync.
Zoom mode (Flash coverage area)	Auto Zoom, 24mm, 28mm, 35mm, 50mm, 70mm, 85mm, 105mm, 135mm and 200mm
Special features	Modelling light on remote flash ⁽²⁾ , Advanced groups ⁽²⁾ , TTL memory
AF-assist beam effective range	0.7 to 5 meters ⁽¹⁾
Display	LCD color display
Firmware update	Micro SD / SDHC (up to 32GB) (Not included)
Power supply	2 x AAA (not included)
Continuous flash speed	Up to 10 shots per second
Battery Life	Approx. 3,000 shots (using alkaline batteries) ⁽¹⁾
Hot shoe	Metal shoe ⁽³⁾ with quick release lock
Size	Approx. 65(W) x 60(H) x 60(D) mm
Weight	73g / 2.6 oz (without battery)
Accessories included	Protection case, 2 shutter release cables

(1) This is a testing result record, it may be affected by equipment and environmental factors.

(2) This is a new feature which supports a coming new NAS flash.

(3) Excludes Sony version.

Warranty

In case of the following reason of the defect, it may void the warranty.

1. The product is not used in accordance with the instruction of the owner's manual.
2. The product is repaired or modified by the one who is not an authorized repair service.
3. When the product is used with the cameras not applicable, lens, adaptors or such accessories produced by the third party.
4. Fault or defect caused by fire, earthquake, flood, public pollution and such natural accident.
5. In case that the product is stored in dust, moisture, extremely high temperature or such poor condition.
6. Scratch, blemish, crush or worn out by a violent use or treatment.
7. Guarantee card without name of place purchased or date of purchase stamped, or no guarantee card.

Please refer the respective warranty condition for details which depends on the country of purchase and contact our official distributors who distributed this product for the warranty arrangement details.

Nissin

Nissin Japan Ltd., Tokyo
<http://www.nissin-japan.com>

Nissin Marketing Ltd., Hong Kong
<http://www.nissindigital.com>