

Precaution

To avoid fire or electrical shock, do not expose this product to rain or moisture.

To avoid short circuit, please make sure the batteries contacts are securely packed and use the battery in accordance with the local provisions.

Please place the batteries and the parts which can be swallowed mistakenly away from children. If swallowed, please get medical help immediately.

To avoid any possible injury to eyes, do not use the flash in a short distance from the eyes.

To avoid any possible safety accident, do not use the flash on the people focusing attention.

Please take out the batteries and stop using this product immediately in case of the following situation:

- This product is dropped or shocked seriously and the inner part of this product is bared.
- Wear gloves and take the batteries out if the corrosive liquid inside the batteries leaks.
- This product gives off strange smell, heat or smokes.

Do not disassemble or maintain this product because the internal high voltage circuit may cause the electric shock.

Please take out all the batteries if this product is not used for a long time.

Features

- **【Wireless System】 Fully Compatible with YN622N and RF603 Wireless Flash System**

One YN685 can receive the wireless triggering signal from YN622N, YN622N II, YN622N-TX, YN660, YN560IV, YN560-TX, RF605, RF603II and RF603 respectively.

- **【Remote Control】 Supports Remote Control the Parameters of Each Flash Group**

When YN685 used as slave unit, it supports remote control of the flash mode, flash output and focal length of each flash group through YN622N series transceiver or YN660/YN560IV/YN560-TX.

- **【Extended Display】 Used as YN622N II control panel and LCD panel**

The YN685 can be set to 622 Ext.LCD trigger mode and then installed on the YN622N II acting as the control panel and LCD panel, makes the operation of the trigger more convenient.

- **【HSS】 Supports High-speed Synchronization**

When the HSS function is enabled, this speedlite can be used at all shutter speed, the maximum sync speed can reach 1/8000s. Note: The function need the support by the camera and transceiver.

- **【High Guide Number】 GN60@ISO100,200mm**

The YN685 is 2.4GHz wireless high guide number speedlite, supports TTL, M, Multi mode.

- **【Upgrade】 Supports Firmware Upgrade**

Users can log in YONGNUO official website to download the latest firmware to upgrade the speedlite, improve the performance of the product timely.

- **【Theme】 Two display themes are designed for YN685**

YN685 supports numeric theme and classic theme, users can choose according to needs.

- **【Charging Recycle】 Ultra-fast Charging Recycle System, Supports External Power Supply**

It just take about 2 seconds at full output. Even if not use the brand new batteries, it just takes 3~5 seconds ultra-fast time to recycle; Besides, you can also use the external power supply to meet your higher requirement.

- **【Zooming】 Supports Auto and Manual Zooming**

Supports auto and manual zooming, the flash coverage can be changed between 20~200mm.

- **【Sound Prompt】 Specific Sound Prompt System**

When the sound prompt system is enabled, the speedlite can prompt its working condition, allows you to focus on creative process. Note: the sound prompt can be turned on/off.

- **Supports Custom Settings (Fn.) and Auto Save Settings**

- **Equipped with LCD display screen and standard PC sync interface**

Catalogue

Precaution	P1
Features	P2
Quick Start	P4
Components Description	P5~9
Preparation	P10~11
Basic Functions	P12~15
Advanced Flash Shooting	P16~19
Wireless Flash Shooting	P20~23
Custom Function Setting	P24~25
Troubleshooting Guide	P26
Specifications	P27~28

In order to get familiar with this product, please read this user manual and take the user manuals of the camera and YN622CN/YN622N II/YN622N-TX as reference.

Icons in this user manual:

 : warning of avoiding shooting problems.

Basic assumption:

* Both the camera and this speed-lite are assumed to set as <ON> in every operating steps.

I.Quick Start

If you don't have much time to read the whole user manual, we advise you to read this section.

1.Please avoid the excessive user of the output with maximum power. It can effectively extend the service life of this product. (It is recommended that the speedlite should be idle for more than 10 minutes when the overheat protection is activated.)

2.Short press [MODE] button to switch the flash mode among E TTL mode, M mode and Multi mode; press and hold [MODE] button to enter into trigger mode to select status; rotate [Select Dial] to select trigger mode: normal set-up→622 Ext. LCD →622.R.SLAVE→622.M.SLAVE.

3.The specific function of the functional buttons (1-4) will be different according to the current flash working state. For more details please refer to the following chapters.

4.Short press [+/-] button to enter into the exposure intensity setting state.

5.Short press [ZM/C.Fn] to enter into the flash coverage setting state; press and hold [ZM/C.Fn] to enter into the custom flash function setting stage.

6.Short press the 【Zm/C.FN】 button,and then short press the 【A ZOOM】 button will quickly turn on the Automatic Zoom function, short press the 【M ZOOM】 button will quickly restore the focal length to the manual focal length set before.

7.Short press [CH] button to enter into the channel setting stage.

8.Short press [Gr] button to switch the control groups of the master unit and the group of the slave unit.

9.The selected flash parameter such as flash intensity, flash coverage range and flash channel can be changed through [Select Dial]; save the parameter settings by short pressing [OK] button.10.Press and hold the function 4 to turn on/off the backlight..Long press button 2 and button 3 to restore the factory settings of this speedlite; please note that the custom settings won't be cleaned.

II.Components Description

1.Nomenclature

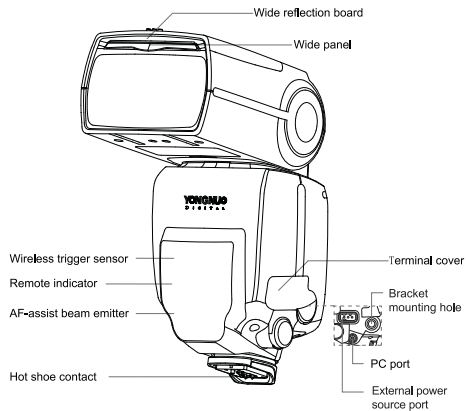

Components Description

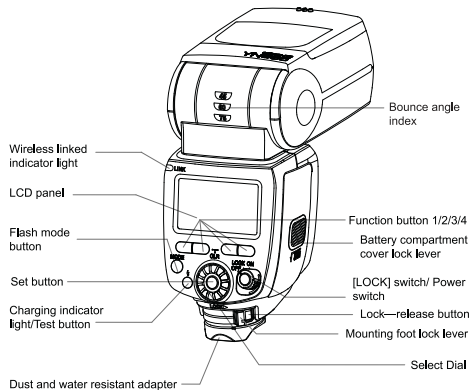

2.LCD panel

i-TTL flash LCD panel

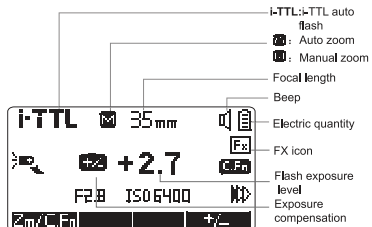

Manual flash LCD panel display

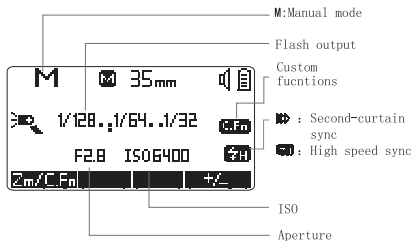

Components Description

Multi flash panel display

MULTI: Stroboscopic flash



Wireless shooting

● 622 Ext. LCD trigger mode panel display



● 622 N/603 SLAVE trigger mode panel display

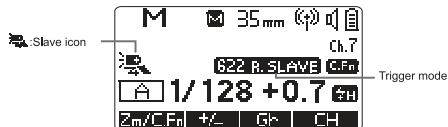

3. Status description

● Status of [Charging Indicator]

Status	Meaning	Treatment
Red light	The speedlite is fully charged and can be used.	Normal
Blue light	The speedlite has not been fully charged.	Waiting for completion of charging.
Blue light blinking	a.Low battery and the speedlite is about to shut down; b.Overheat prompt.	a.Please replace new batteries; b.Reduce the frequency or stop firing until the speedlite cool down.
Red light blinking	Overheat prompt.	Reduce the frequency or stop firing until the speedlite cool down.
Red light and blue light blinking	Overheat protection mechanism is activated.	Stop firing until the speedlite cool down.

● Status of [Link]

Status	Meaning	Treatment
Blue light	communicating	Normal
Red light	Trigger or to be triggered	Normal

● Sound Prompt

The sound Form	Meaning	Treatment
Tick twice	The sound indicator is enabled, and the speedlite is started and ready to fire.	Normal
Three tick, two times	The exposure may be excessive.	Adjust exposure compensation or change shooting condition.
Tick tick tick	The exposure may be insufficient.	Adjust exposure compensation or change shooting condition.
Tick-tick Tick-tick twice	The speedlite is charging.	Waiting for completion of charging
Tick-a long sound	The speedlite is fully charged and can be used.	Normal
Tick continuously and quickly	Low battery and the speedlite is about to shut down.	Replace the batteries.
Tick-tick-tick	Go to dormant state and the speedlite shuts down automatically.	Shut down and restart it.

III.Preparation

1.Install Batteries

Slide the [battery compartment cover] in the direction of the arrow as shown.

Insert the batteries according to the label inside the battery chamber and make sure the direction of the battery contact (+/-) is correct.

Close the [battery compartment cover] in the direction of the arrow as shown.

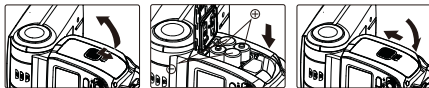

Please use four standard specification AA batteries. To avoid circuit, please do not use damaged batteries.

2.Attaching to the Camera

Slip the speedlite' s [mounting foot] all the way into the camera' s hot-shoe.

Slide the [mounting foot lock lever] to the right side as the arrow shown until the "clicks" sound is heard.



3.Detaching from the Camera

To detach the speedlite from the camera, press the [lock-release button] and slide the [mounting foot lock lever] to the left side, then detach the speedlite.

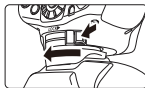

4. Power-on and Power-off

Set the switch to <ON> position, the speedlite is on and starts charging; after turned on, the <Charging Indicator> is bright with red light which indicates it can flash.

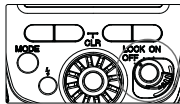

If the charging is not completed within 30 seconds, the <Charging Indicator> will be blinking with blue light, the screen displays the low power icon and shutdown automatically. If so, it indicates the speedlite needs to be replaced with new batteries.

After use, set the switch to <OFF> position to turn off the power source. Please take out the batteries after turning off the power of the speedlite.

5. Lock Function

Set the switch to <LOCK> position, [Select Dial] and other buttons of this speedlite will be locked. With this function, the setting parameters defined will be protected from being changed accidentally. When this function is enabled, the LCD screen displays <LOCKED>.

6. Test Flash

When the charging indicator turns red, you can test the flash is normal or not through [TEST] button.

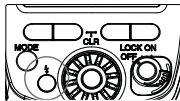

IV.Basic Functions

1.Display Themes

Two display themes are designed for YN685: numeric theme and classic theme. When the display theme showed on the LCD screen is numeric theme, the flash intensity parameters in all flash modes are showed as pure numerical form in a big size font; when it's classic theme, the flash intensity parameters in all flash modes are showed as scaleplate and numbers. Please choose the theme according to your preference.

For more setting details about display theme please refer to the following chapters. (Page 25)

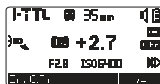

classic theme



classic theme

2.i-TTL Mode

In i-TTL mode, the metering system of this camera will detect flash illumination reflected back from the object so as to automatically adjust the exposure compensation. In i-TTL mode, the light intensity can be adjusted by setting FEB, FEC and exposure lock. For more setting details please refer to the following chapters.

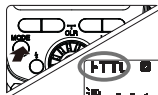

3.M Mode

Short press [MODE] button to switch this speedlite to M mode and you can set flash output according to your requirement. The adjustment range of flash output is 1/128~1/1. Short press functional button [+/-], after the flash output is highlighted, adjust the flash output through [Select Dial], and then save settings by pressing [OK] button.

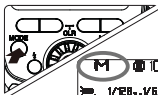

4. Multi Mode

By short pressing [MODE] button this speedlite is switched to Multi mode; then set flash output, flash frequency and number of flashes according to your requirement. Short press [+/-] button to select flash output, [MULT] button to select number of flashes and [Hz] button to select flash frequency. After the selected items are highlighted, set the parameters through [Select Dial] and save the settings by pressing [OK] button.

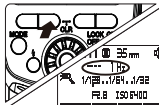
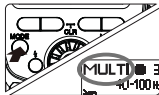

The adjustment range of flash output is 1/128-1/64-1/32-1/16-1/8-1/4; the number of flashes range and flash frequency range is 1~100. When the number of flashes is set as “—”, this speedlite will keep flashing till the shutter closed or the batteries run out.



when in low battery, the charging speed of speedlite will be slow, which may cause the leakage of the stroboscopic flash. In this situation, please reduce the flash frequency or change new batteries.

5. Wireless Mode

Press and hold [MODE] button to enter into trigger mode to select status; rotate [Select Dial] to select trigger mode: normal set-up→622 Ext.LCD→622 R.SLAVE→622 M.SLAVE→normal set-up. When < > icon displaying on the LCD screen, it indicates that this speedlite is in wireless slave mode. YN685 can receive the wireless triggering signal from YN622N, YN622N II, YN622N-TX, YN660, YN560IV, YN560-TX, RF605, RF603II and RF603 respectively. With YN622N series transceiver, YN660, YN560IV and YN560-TX, the flash mode, flash intensity and zoom of each flash group can be remotely controlled. For more setting details please refer to the following chapter “Wireless Flash Shooting” (Page 20).

6. Power Saving Mode

Power saving mode is designed for YN685.

When power saving mode is enabled, the speedlite will go to sleeping mode if it leaves idle. <  > will display on the LCD screen when it's in sleeping mode, you can wake up this speedlite by short pressing [TEST] button. For more specific settings please refer to "Custom Function Setup"(Page 24).

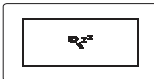

7. Overheat protection

If this speedlite is used too frequently, the temperature of the flash head will rise.

When the inner temperature of this speedlite rise, the overheating prompt will be displaying on the LCD screen:

Display	Overheating warning
Icon	
Status of Charging indicator	Red light or blue light blinking

When the overheating level goes to level 2 and the speedlite keeps flashing, the overheat protection will be activated; the overheat protection icon <  Hot > will be displayed on LCD panel and the charging indicator will alternately flashes blue and red light. When the overheat protection is activated, this speedlite can't fire, and please keep it idle for 10 minutes or more until it cools down.



- The cycle time will extend when the speedlite warns overheating.
- When the speedlite warns overheating, please reduce the use intensity.
- Please mind the hot batteries when you take them out after the continuous shooting.

8. Modeling Flash

Operate the aperture preview button on the camera, the speedlite will flash continuously for 1 second. This is so-called modeling flash. For more specific operation, please refer to the user manual of the camera.



Please keep the number of modeling flashes under 10 times; keep the speedlite idle for 10 minutes or more after the continuous use of modeling flashes to prevent this speedlite from overheating or burning-out.

9. PC Sync Port (input)

YN685 is equipped with standard PC sync port. Through connecting to the PC sync port, this speedlite can be triggered synchronously.

10. Automatic Setting Saving

This speedlite will automatically save the current settings; this is convenient for you to use the speedlite next time.

11. Clear Settings

By pressing both button 2 and button 3 for 2 seconds, the flash settings will be restored to default settings except the custom function settings.





For more details about how to restore the custom function settings please read the chapter <Custom Function Setting> (Page 24).

V. Advanced Flash Shooting

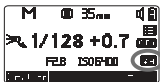

1.High-speed Sync Flash

With high-speed sync (FP flash), the flash can be synchronized with all shutter speeds, the maximum shutter sync is up to 1/8000. High-speed synchronization is particularly convenient to use aperture priority to fill flash for the portraits. Through the camera menu, set the flash sync speed to Auto FP, the speedlite will enable the high-speed sync function automatically.



 The high-speed sync function can only be used when it is supported by your camera, about whether the camera supports this function please refer to the camera manual.

2.Second-curtain Sync

After the second-curtain sync enabled, the speedlite will flash at the moment when the shutter is going to be shut. Use the slow-speed shutter and second-curtain sync can make image tail for the shooting subject. The second-curtain sync function can only be used when it is supported by your camera, about whether the camera supports this function please refer to the camera manual. When the function enabled, the speedlite screen will display the <  > icon. When the second-curtain sync and high-speed sync function are enabled at the same time, the screen will display the <  > icon.

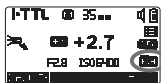
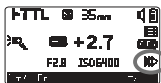

3.Flash Exposure Compensation

In order to make the shooting effect more suitable to your needs, you can set the flash exposure compensation through the camera or on the speedlite. The exposure compensation value range is within the

range of $-3EV \sim +3EV$, the increment with $1/3EV$. Short press the function button **【+/-】** to choose the exposure compensation amount, rotate the **【Select Dial】** to adjust the exposure compensation, then press the **【OK】** button to save settings.

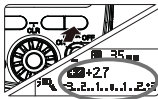

When the Speedlite, camera and trigger have set the exposure compensation at the same time, which will overlap the exposure compensation.

4. Exposure Bracketing (FEB)

The exposure bracketing can be set through the camera. After the exposure bracketing being set, after every 3 photos being taken, exposure compensation will be made automatically, for example, exposure in the sequence of "normal → under → over". This function helps you improve the success rate of shooting. The function need to operate on the camera, for the detailed operation method please refer to your camera manual.



When using the exposure bracketing, we suggest you set the driving mode of the camera as "single shot", and check if the flash back to full charge before shooting.

5. FV Lock

To use this function should be first set the **【AE/AF-L】** function button to "FV Lock" on the camera. At the moment please focus on the subject through the view window, and then press the **【AE/AF-L】** button. The speedlite will fire pre-flash to obtain the flash exposure degree of the subject. Then press the camera shutter when you confirm the shooting scene framework.





The function can only be used when it is supported by your camera. For the setting method please refer to your camera manual.

6.The Flash Range Setting

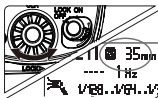
You can set the flash range to "Auto zoom" or "Manual zoom". When set to "Auto zoom", the flash will automatically adjust the flash range according to the focal length. When set to "Manual zoom", you can set the flash range between 20mm~200mm. Short press the **【Zm/C.Fn】** button to choose the flash range value, then adjust the flash range through the **【Select Dial】**, press the **【OK】** button to save settings. The icon



<  > means auto zoom, while the icon <  > means manual zoom. Short press the **【Zm/C.FN】** button, and then short press the **【A ZOOM】** button will quickly turn on the Automatic Zoom function, short press the **【M ZOOM】** button will quickly restore the focal length to the manual focal length set before.

7. Use the External Battery Pack

You can purchase the external battery pack SF-18C or SF-17C, connect it to the external power socket of YN685, after flash the battery pack will charge for the speedlite.

8.High-speed Continuous Shooting

The speedlite can support the high-speed continuous shooting function. Please set the camera in the continuous shooting mode and then shoot.



The quantity of photos can be continuous taken is related with the flash output setting and battery capacity. Please use the battery with enough electric quantity.

9. Reflection Flash

Bounce flash means taking photos by making flash light head aimed at wall or ceiling and using the light reflected back from the ceiling or wall to light the desired object. So that the shade behind the object can be lightened to get more natural shooting effect.

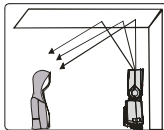

A If the wall or ceiling is too far, the bounce flash may be too weak to get enough exposure. The wall or ceiling should be even and white in order to get efficient reflection; if the reflection surface is not white, color cast may appear in photo.

10. Use Reflection Board for Shooting

When using the [Reflection board] in flash, pull the [Reflection board] and the [Wide panel] out from the light head, then push back the [Wide panel]. If shooting in such case, it will produce a highlighted point on the eyes of the subject and thus make the eyes charming (catching light). This function can reach better effect if adjusting the flash head up to 90°.

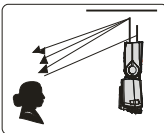

11. Use Wide Panel

Pull out the [Wide panel], push back the [Reflection board] and arrange them as per the figure; in such case, the flash range will extent to 14 mm, the flash range will be enlarged and the effect will be softer and more natural.

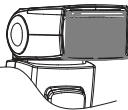

A When the [Wide panel] being pulled out, the flash range will be locked to 14mm and could not be adjusted.

VI. Wireless Flash Shooting

YN685 is compatible with YN622N and RF603 Wireless Flash System. It can receive the wireless triggering signal from YN622N-TX, YN622N, YN622N II, YN660, YN560 IV, YN560-TX, RF605, RF603 II and RF603 respectively. Under the premise of the master unit supported, the YN685 can easily realize multiple speedlite off camera TTL, M, multi flash. Besides, it can also remote control each group of the flash mode, flash output, focal length and synchronization mode. Long press the **【MODE】** button to enter into the trigger mode selection, through rotating the **【Select Dial】** to select the trigger mode (ste-top → 622 Ext. LCD → 622 R.SLAVE → 622 M.SLAVE → 603 SLAVE → set-top) then press **【OK】** button to save the settings.

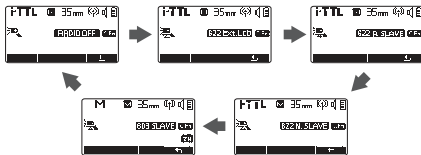

- Some functions in wireless flash shooting need to set up on the master unit, the relevant settings of master unit please refer to the manual of the master unit.
- In the triggering mode, please make sure the slave unit accord with the master unit.
- If you want to control the flash range of slave unit through the master unit, the slave unit must set the flash range to "Auto zoom".
- YN685 can not be bused directly as a master unit.

1.622N Wireless System

YN685 can match with the YN622N-TX, YN622N and YN622N II to complete the whole set of wireless flash system.

When the YN685 used with the YN622N-TX or YN622N for wireless flash shooting, the speedlite need to switch to 622N off camera mode

(622 R.SLAVE或622 M.SLAVE) .

For the YN685,there are 7 channels and 3 groups for option in the 622N wireless flash system.Through short pressing the [CH] button can enter into the channel setting state,rotate the [Select Dial] can adjust the channel,then press the[OK]button for saving. Short press the function button [Gr] can switch the slave unit group directly.

(1) YN622N II Extend Display Function

When the YN622N II act as master and set to 622 communicate mode, the YN685 which has been set up 622 Ext.LCD trigger mode can be installed on the transmitter acting as the control panel and LCD panel.Short press the 【Gr】 button to enter the group setting mode,rotate the 【Select Dial】 to adjust the control group.When the LCD displays the current group,said it can adjust the parameter of the flash group.Such as:when the on-camera flash LCD displays the grouping is M,it indicates it is in on-camera flash parameter setting;when the on-camera flash LCD displays the grouping is A,it indicates it is in the group A flash parameter adjust.



 This function requires use with YN622N II,otherwise it will not work.

(2) Remote Control Mode

When the YN685 set to "622 R. SLAVE " trigger mode,the flash mode,flash output and synchronization mode will completely controlled by the master unit.



(3) Mixed Mode

When the YN685 set to "622 M.SLAVE"slave mode,you can set the M or Multi mode on the speedlite,and set the flash output which



Wireless Flash Shooting

does not changed by the master unit,the setting method is the same as normal on camera trigger mode.



If you need to use the off-camera TTL mode,please switch to the remote control trigger mode.

2.603 Wireless System

For the YN685,there are 16 channels and 6 groups for option in the 603 wireless flash system.Short press the function button [Gr] can switch the slave unit group directly;Short pressing the [CH] button can enter into the channel setting state,rotate the [Select Dial] can adjust the channel,then press the[OK]button for saving.Under the 603 SLAVE state,the setting method of the flash mode,flash output,focal length is the same as on-camera trigger mode.For the method of remote control the parameter please refer to the manual of master unit.



3.Multi-flash Wireless Flash Configuration

You can create two or multiple slave groups to realize shooting multiple needs.In the shooting process, you can use the speedlite with the master unit to set different flash mode,flash output and focal length for each group of slave units according to your actual shooting demand.

(1) Wireless flash of two slave units made up by YN685

Set the off camera trigger mode:there are 622 R.SLAVE/622 M.SLAVE and 603 SLAVE for option.
Setup communication channel: Set the channel of the master unit and slave unit in consistent.For the 622N trigger mode,there are 7 channels for option;and for the 603 trigger mode,

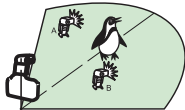

there are 16 channels for option.

Group setting: Set the two YN685 to any two groups respectively.

The flash parameters setting of slave unit: Set the flash mode, flash output and focal length on the speedlite or master unit.

(2) Wireless flash of three slave units made up by YN685

The setting method of forming three slave unit of wireless flash is the same as setting method of two slave units of wireless flash. However, it can set the slave unit to 3~6 respectively. In shooting process it can follow the arrangement of the flash effect as you need.

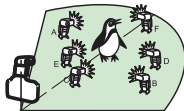

When you need bigger flash output, you can increase the slave unit. Just need to increase slave units on the flash group, if you want to increase the flash output. For example: if you need to increase the flash output of group A, please set the three slave units as group A, then the three flash is equivalent to controlling flash on the flash group A.

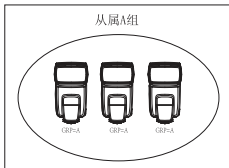

VII. Custom Function Setting

You can custom the flash function according to your requirement. Long press the function button **【Zm/C.Fn】** to enter into the custom function menu, rotate the **【Select Dial】** to select the custom function item (Number, such as C.Fn 01), short press the **【OK】** button to enter into the submenu, change the function settings of submenu through the **【Select Dial】**, then short press the **【OK】** button for save settings and exit the submenu. After the custom function setting completed, press the **【Return】** button back to the shooting interface. Short press the function button **【CLEAR】**, then short press the **【OK】** button then the custom option will restore to factory default.

The custom function supported by YN685 is as below:

C.Fn 01 Power saving mode

0: ON Enable the power saving mode

1: OFF Turn off the power saving mode

C.Fn 02 Power automatic off of the slave unit

0: 60min Power automatic off of the slave unit is 60 minutes

1: 10min Power automatic off of the slave unit is 10 minutes

C.Fn 03 Slave auto power off timer

0: 4h Slave auto power off within 4 hours

1: 1h Slave auto power off within 1 hours

C.Fn 04 AF-assist beam

0: ON Enable the AF-assist beam

1: OFF Turn off the AF-assist beam

C.Fn 05 Flash coverage format

0: FX FX format

1: DX DX format

C.Fn 06 Sound prompt

0: OFF Turn off sound prompt

1: ON Enable sound prompt

C.Fn 07 Theme

0: NUMERIC Numeric theme

1: CLASSIC Classic theme

C.Fn 08 Background light

0: 12sec The display time of background light is 12 seconds

1: OFF Turn off the background light

2: ON Background light long on

C.Fn 09 Contrast control

For the display contrast adjustment, total of 15 levels for option.

C.Fn 10 Background light Brightness

For the background light brightness adjustment, total of 28 levels for option.

C.Fn 11 Slave unit indicator light

0: ON Enable the slave unit indicator light

1: OFF Disable the slave unit indicator light

C.Fn 12 Firmware Version

Display the information of current version for the flash.



Long press the function button 4 can quick turn on 12 seconds lighting or quick turn off the background light.

VIII.Troubleshooting Guide

1. Unable to turn on the power source or unable to flash

Please ensure the battery in correct installation;Ensure the hot shoe contact between flash and camera are in good contact;Please clean the contact if the hot shoe contact of flash and camera got dirty.

2. The flash automatically shut off the power

Please check if the flash enable the power saving mode or whether the battery power is enough.

3.Photo underexposed or excessive

Check if the shutter speed,aperture,ISO too close to the flash limit or have set the relevant setting of the exposure compensation,exposure bracketing and etc;on the premise of the flash not beyond the flash limit,if the exposure effect is still not ideal,please appropriate increase or decrease the exposure compensation or flash output;when enable the high-speed synchronization,the effective flash range will become shorter,please close to the object.

4.At the bottom of the pictures appears dark

When the flash close to the shooting object,please adjust the vertical rotation angle of flash head to -7° .

5.The image edge appears dark

When the flash using manual zoom,please set the flash range wider than view angle.

6.The slave unit does not flash

Please check whether the channels of slave unit and master unit are accordant or not;please ensure the slave unit is in the effective flash range of master unit;check if the master unit set the group of slave unit as not participate the flash.

7.Other abnormal phenomenon

Try to clear the settings of flash and camera;try to disable the flash power source and then restart the flash. If the problem still not be solved,please contact to YONGNUO after-sale service center with hot line 400-001-3888.

This device complies with Part 15 of the FCC Rules. Operation is subject to the following two conditions: (1) this device may not cause harmful interference, and (2) this device must accept any interference received, including interference that may cause undesired operation.

Changes or modifications not expressly approved by the party responsible for compliance could void the user's authority to operate the equipment.

NOTE: This equipment has been tested and found to comply with the limits for a Class B digital device, pursuant to Part 15 of the FCC Rules. These limits are designed to provide reasonable protection against harmful interference in a residential installation. This equipment generates, uses instructions, may cause harmful interference to radio communications. However, there is no guarantee that interference will not occur in a particular installation. If this equipment does cause harmful interference to radio or television reception, which can be determined by turning the equipment off and on, the user is encouraged to try to correct the interference by one or more of the following measures:

- Reorient or relocate the receiving antenna.
- Increase the separation between the equipment and receiver.
- Connect the equipment into an outlet on a circuit different from that to which the receiver is connected.
- Consult the dealer or an experienced radio/TV technician for help.