

JÖBY®

Wavo POD

Microphone

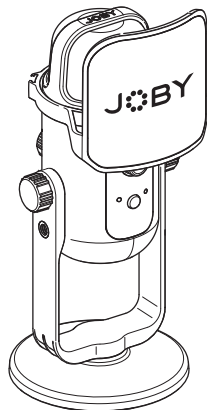

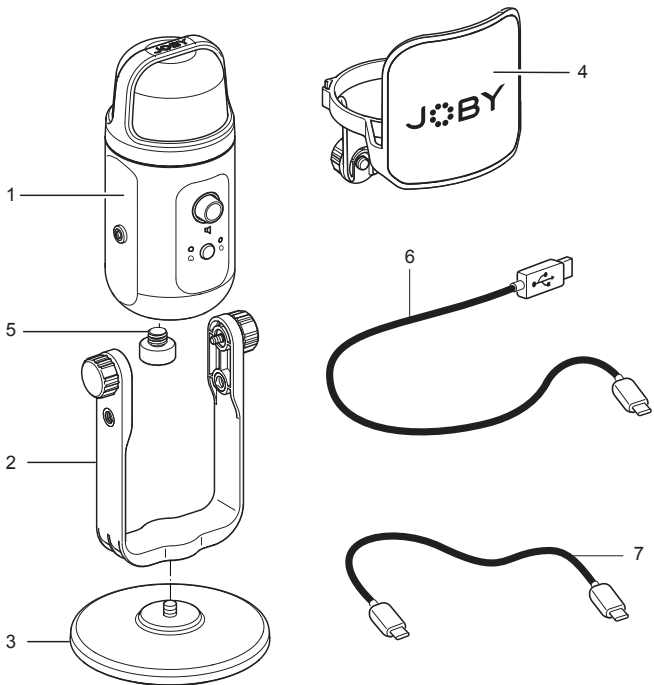

1

WHAT'S IN THE BOX

- 1 Microphone body
- 2 U bracket with mounting screws
- 3 Desk base
- 4 Pop filter
- 5 3/8" to 5/8" adapter
- 6 USB type C to USB type A cable (3m/9.8ft)
- 7 USB type C to USB type C cable (2m/6.6 ft)

CONTENU DE LA BOÎTE

- 1 *Corps du microphone*
- 2 *Support en U avec vis de montage*
- 3 *Socle*
- 4 *Filtre anti-souffle*
- 5 *Adaptateur 3/8" vers 5/8"*
- 6 *Câble USB type C vers type A (3 m /9,8 ft)*
- 7 *Câble USB type C vers type C (2 m /6,6 ft)*

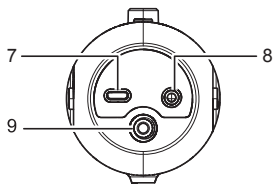
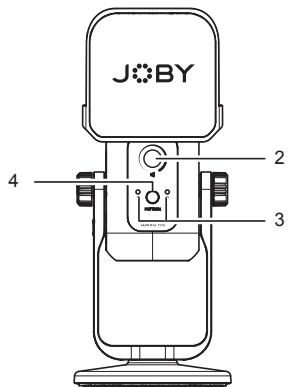
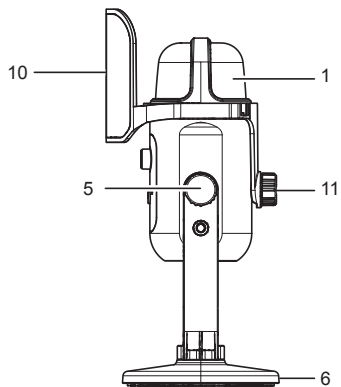

2

PRODUCT DESCRIPTION



- 1 Microphone capsule & protective grille
- 2 Multi function dial
- 3 Polar pattern indicators
- 4 Polar pattern switch:

Press to toggle between cardioid  or omnidirectional  mode

- 5 Adjusting screws
- 6 Desk stand
- 7 Type C usb port
- 8 Headphone jack
- 9 3/8 mounting hole & 3/8 to 5/8 adapter
- 10 Pop filter
- 11 Pop filter mounting screw

PRODUCT DESCRIPTION

- 1 *Microphone capsule & protective grille*
- 2 *Multi function dial*
- 3 *Polar pattern indicators*
- 4 *Polar pattern switch:*

appuyez pour basculer entre le mode cardioïde  et omnidirectionnel 

- 5 *Vis de réglage*
- 6 *Socle du pied*
- 7 *Port USB de type C*
- 8 *Prise casque*
- 9 *Trou de fixation 3/8 et adaptateur 3/8 à 5/8*
- 10 *Filtre anti-souffle*
- 11 *Vis de montage du filtre anti-souffle*

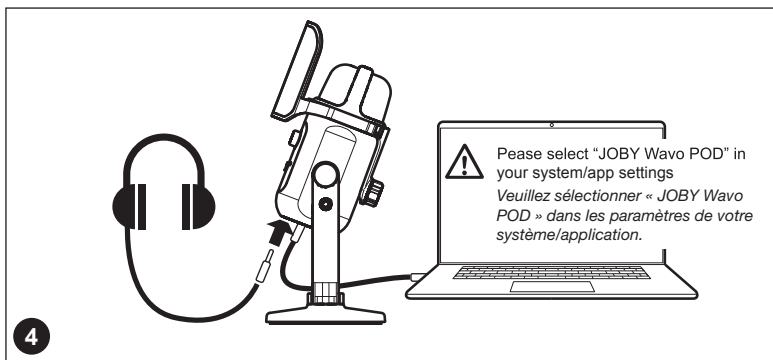
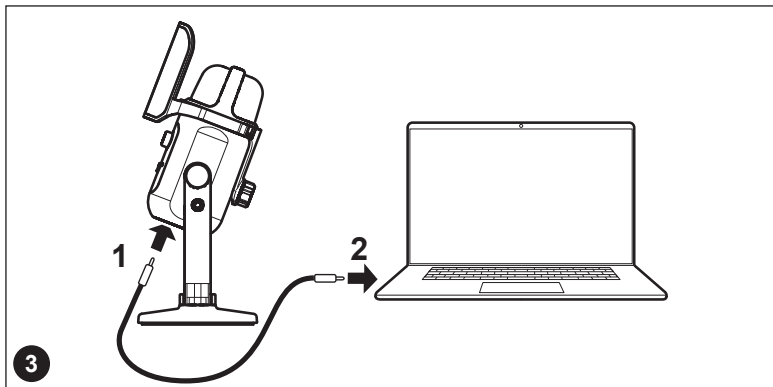

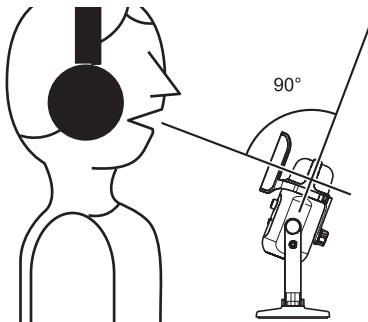
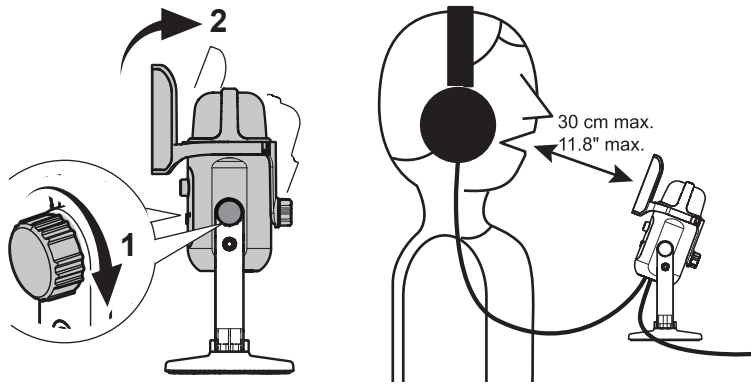

5

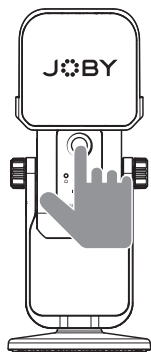

blue light
Voyant bleu

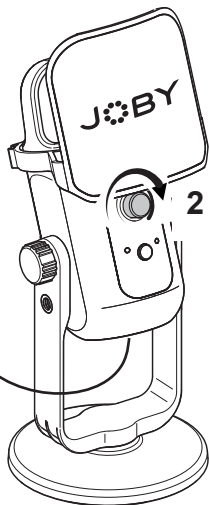

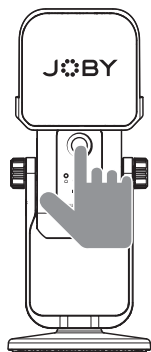

purple light
Voyant violet

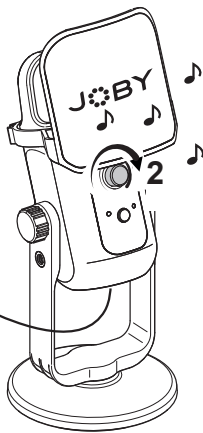
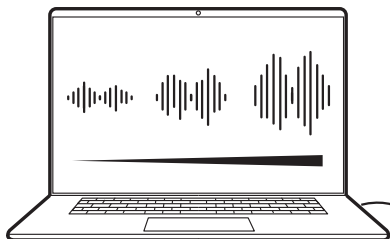

7

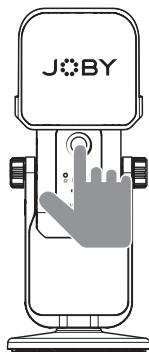

red light
Voyant rouge



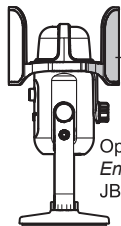
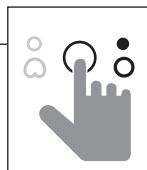
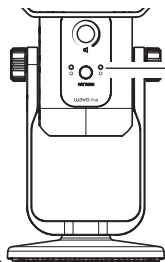
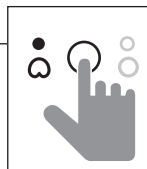
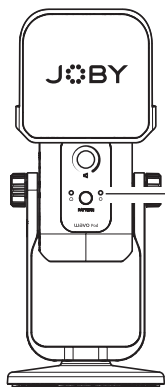

Optional
En option
JB01800-BWW

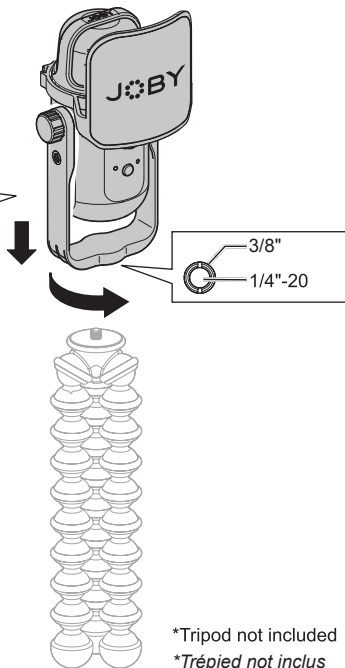
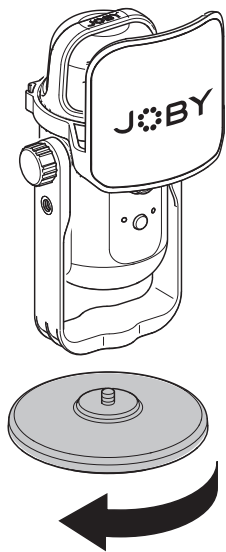

*Tripod not included
*Trépied not inclus

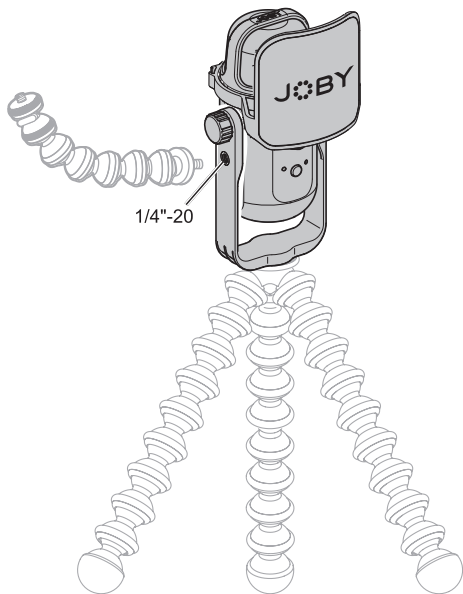

*Tripod and arm not included

*Bras de perche non inclus

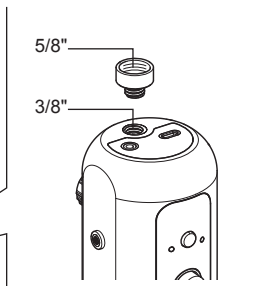
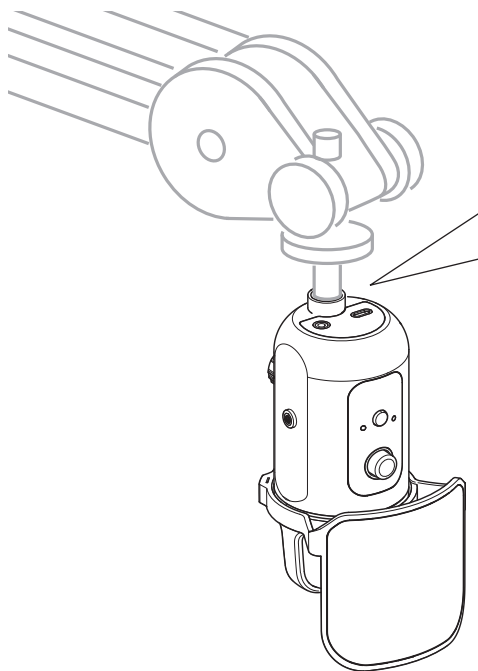

12

*Boom arm not included
*Bras articulé non inclus

DISCLAIMER

The information contained in this document is subject to change without notice.

Vitec Imaging Solutions makes no warranty and shall not be liable for any errors on information contained in this document.

Any changes or modifications not expressly approved by Vitec Imaging Solutions could void the user's authority to operate this equipment.

INFORMATION FOR USERS



In accordance with Article 10 of Directive 2012/19/UE of the 04/07/2012 concerning Waste Electrical and Electronic Equipment (WEEE).

The above symbol, also present on equipment, indicates that, at such time as the user should decide to dispose of the equipment, it must NOT be disposed of as unsorted municipal waste, but must be collected separately. The same applies to all components of the equipment and any recharge or refill elements that the product may comprise.

For information on the waste collection systems suitable for this equipment, contact Vitec Imaging Solutions or any authorised member of the National Registers in EU countries. Household (or similar) waste may be disposed of via standard municipal differentiated waste collection schemes.

If you purchase a new version of this model or similar equipment - or if your existing equipment measures less than 25 cm - you may return the items you no longer require to your retailer who will take care of contacting the company or organization handling the proper collection and management of used equipment.

Correct separate collection and specific treatment of WEEE are necessary to avoid potential damage to human health and the environment, and favour the recycling and recovery of component materials.

Improper or illegal disposal of this product by the user will result in punishments or fines being applied in accordance with national Decrees based on Directive 91/156/EC and 2008/98/EC.

Thank you for purchasing a JOBY product.

JOBY products are warranted to be fit for the purpose for which they have been designed, and to be free from defects in materials and workmanship. This guarantee does not cover the product against subsequent damage or misuse. The period of validity of the Standard Limited Warranty is defined by the law in force in the country, state or region where the product is sold. Please retain your receipt as proof of purchase to repair your product under warranty.

ESCLUSIONE DI RESPONSABILITÀ

Le informazioni riportate in questo documento sono soggette a variazioni senza preavviso.

Vitec Imaging Solutions non rilascia garanzie e non assume responsabilità per eventuali errori nelle informazioni riportate in questo documento.

Qualunque variazione o modifica apportata senza espressa approvazione di Vitec Imaging Solutions può annullare il diritto dell'utente di impiegare questo apparecchio.

INFORMAZIONE AGLI UTENTI



Ai sensi dell'art. 10 della Direttiva 2012/19/UE del 04/07/2012 sui rifiuti da apparecchiature elettriche ed elettroniche (RAEE).

Il simbolo sopra riportato, presente anche sull'apparecchiatura, indica che essa deve essere oggetto di raccolta separata nel momento in cui l'utilizzatore decide di disfarsene (inclusi tutti componenti, i sotto-insieme e i materiali di consumo che sono parte integrante del prodotto).

Per l'indicazione sui sistemi di raccolta di detti apparecchi vi preghiamo di contattare Vitec Imaging Solutions o altro soggetto iscritto nei vari Registri Nazionali per gli altri Paesi dell'Unione Europea. Il rifiuto originato da nucleo domestico (o di origine analoga) può essere conferito a sistemi di raccolta differenziata dei rifiuti urbani.

All'atto dell'acquisto di una nuova apparecchiatura o, senza obbligo di un acquisto nuovo, per le apparecchiature con dimensioni inferiori ai 25 cm, è possibile riconsegnare al rivenditore il vecchio apparecchio. Il rivenditore si farà poi carico di contattare il soggetto responsabile del ritiro dell'apparecchiatura.

L'adeguata raccolta separata dell'apparecchio dismesso e l'avvio alle successive operazioni di trattamento, recupero e smaltimento ambientalmente compatibile, consente di evitare potenziali effetti negativi sull'ambiente e sulla salute umana, e favorisce il riciclaggio ed il recupero dei materiali componenti.

Lo smaltimento abusivo del prodotto da parte dell'utente comporta l'applicazione delle sanzioni previste dai recepimenti nazionali delle Direttive 91/156/CE e 2008/98/CE.

Vi ringraziamo per l'acquisto di un prodotto JOBY.

I prodotti JOBY sono garantiti per essere idonei allo scopo per il quale sono stati progettati ed esenti da difetti nei materiali e nelle lavorazioni. La presente garanzia non copre il prodotto contro danneggiamenti o uso improprio. Il periodo di validità della Garanzia Standard è definito dalla legislazione vigente nel paese, stato o regione nel quale il prodotto viene venduto. Vi preghiamo di conservare una copia della prova d'acquisto del vostro prodotto, poiché vi verrà richiesta in caso di riparazione.

AVIS DE NON RESPONSABILITÉ

Les informations contenues dans cette notice d'utilisation peuvent être sujettes à modification sans avis préalable.

Vitec Imaging Solutions ne peut garantir que le présent document ne contient aucune erreur relative aux informations contenues et ne saurait en être tenu responsable.

Toute modification non expressément approuvée par Vitec Imaging Solutions peut annuler le droit de l'utilisateur à exploiter cet équipement.

INFORMATION AUX UTILISATEURS



Conformément à l'article 10 de la Directive 2012/19/UE du 04/07/2012 relative aux déchets d'équipements électriques et électroniques (DEEE).

Le symbole ci-dessus, qui apparaît sur les équipements concernés, indique que ceux-ci ont été mis en vente après le 13/08/2005 et ne devront par conséquent PAS être jetés avec les ordures ménagères mais faire l'objet d'une collecte sélective lors de leur mise au rebut. Cette mesure s'étend également aux composants, matières et énergie que ces équipements peuvent contenir.

Pour en savoir plus sur les systèmes de collecte de ce type d'équipements, merci de contacter Vitec Imaging Solutions ou tout autre membre agréé inscrit aux Registres nationaux des pays de l'UE. Les déchets domestiques et assimilés peuvent être jetés dans les conteneurs municipaux correspondants.

Si vous achetez une nouvelle version de ce modèle ou un équipement similaire - ou si votre équipement actuel mesure moins de 25 cm - vous pouvez retourner le précédent produit chez votre revendeur qui prendra soin de contacter l'entreprise ou l'organisme responsable de la collecte et du traitement de ce type de déchets.

Une collecte et un traitement adaptés des DEEE sont indispensables pour éviter les risques potentiels pour la santé et l'environnement et favoriser la récupération et la valorisation des matériaux qui les composent.

Toute élimination incorrecte ou illégale du présent produit condamnera l'utilisateur à une peine ou une amende conformément aux décrets nationaux appliquant les Directives 91/156/CE et 2008/98/CE.

Merci d'avoir acheté un produit JOBY.

Les produits JOBY sont garantis pour un champ d'utilisation correspondant à celui pour lequel ils ont été conçus, sans malfunctions humaines ou matérielles. Cette garantie ne couvre pas le produit contre des dommages ou des mauvaises utilisations. La période de validité de la Garantie Standard est définie par la loi en vigueur dans le pays, l'état ou la région où le produit est vendu. Merci de conserver votre preuve d'achat afin de pouvoir faire réparer votre produit sous garantie.

RECHTLICHE HINWEISE

Die in diesem Dokument enthaltenen Informationen können ohne Vorankündigung geändert werden.

Vitec Imaging Solutions übernimmt keinerlei Gewähr und lehnt ausdrücklich jegliche Haftung für eventuelle in dieser Anleitung enthaltene Fehler oder Auslassungen ab.

Jegliche Änderungen oder Modifikationen, die nicht ausdrücklich von Vitec Imaging Solutions genehmigt wurden, kann die Berechtigung des Benutzers zum Betrieb dieses Geräts aufheben.

VERBRAUCHERHINWEISE

Betrifft Paragraph 10 der Richtlinie 2012/19/EU vom 04.07.2012 über die Entsorgung elektrischer und elektronischer Geräte (WEEE).



Das obenstehende Symbol, das sich auch auf dem Gerät findet, sagt aus, dass das Gerät nach dem 13.8.2005 auf den Markt gekommen ist und damit der Regelung unterliegt, der zufolge der Endverbraucher für seine Entsorgung verantwortlich ist. Es darf nicht mit dem normalen Hausmüll entsorgt werden, sondern ausschließlich als Sondermüll.

Dasselbe gilt für sämtliche Bauteile des Geräts sowie eventuell vorhandene Nachfüll- oder Auflade-Elemente.

Informationen über die für dieses Gerät geeignete Entsorgung sind erhältlich von Vitec Imaging Solutions oder jedem autorisierten Mitglied des Nationalregisters in Ländern der EU. Haushalt- (oder ähnlicher) Müll darf nach den Mülltrennungs-Vorschriften der jeweiligen Gemeinde entsorgt werden.

Wird dieses oder ein ähnliches Gerät neu gekauft, oder wenn Ihr jetziges Gerät die Größe von 25 cm unterschreitet, kann das alte Gerät an den Verkäufer zurückgegeben werden, der sich seinerseits mit der zuständigen Firma oder Körperschaft in Verbindung setzen wird, die für die Einsammlung und Verwertung gebrauchter Geräte zuständig ist.

Mülltrennung und die korrekte Entsorgung von WEEE dienen dem Gesundheits- und Umweltschutz. Sie unterstützen das Recycling und die Wiederverwendung wertvoller Rohmaterialien.

Unschämeartige oder illegale Entsorgung dieses Produkts durch den Endverbraucher wird gemäß dem nationalen Dekret auf Grundlage der Richtlinien 91/156/EC und 2008/98/EC bestraft.

Vielen Dank, dass Sie sich für ein JOBY Produkt entschieden haben.

JOBY garantiert, dass die Produkte für den Zweck, für den sie entwickelt wurden, geeignet und frei von Fehlern in Material und Verarbeitung sind. Diese Garantie deckt das Produkt nicht bei Folgeschäden oder Missbrauch. Die Gültigkeitsdauer der Standardgarantie wird durch das jeweilige geltende Recht des Landes, des States oder der Region, in dem das Produkt verkauft wird, bestimmt. Bitte bewahren Sie den Kassenbon als Kaufbeleg auf, damit Ihr Produkt im Rahmen der Garantie repariert werden kann.

EXENCIÓN DE RESPONSABILIDAD

La información contenida en este documento está sujeta a cambios sin previo aviso.

Vitec Imaging Solutions no establece garantía alguna ni se hace responsable por errores en la información contenida en este documento.

Cualquier cambio o modificación en la unidad no aprobado expresamente por Vitec Imaging Solutions es susceptible de dejar al usuario sin la autorización para utilizar este equipo.

INFORMACIÓN PARA LOS USUARIOS



De acuerdo con el Artículo 10 de la Directiva 2012/19/UE con fecha 04/07/2012 concerniente a los residuos de Equipamientos Eléctricos y Electrónicos (WEEE).

El símbolo de la parte superior, también presente sobre los equipos indica que el equipo fue vendido después del 13/8/2005 y por tanto a partir de dicha fecha, el usuario que decidía deshacerse del equipo, no deberá tirarlo a un contenedor municipal de basura sin clasificar, sino que debía recogerse separadamente. Lo mismo se aplica a todos los componentes del equipo y a cualquier elemento que pueda recargarse o rellenarse que pueda contener el equipo.

Para información sobre sistemas de recogida de residuos adaptables a su equipo, contacte a Vitec Imaging Solutions o a cualquier miembro autorizado de los Registros Nacionales de Europa. La caja (o basura similar) puede eliminarse mediante los sistemas de recolección de residuos diferenciados municipales.

Si usted adquiere una nueva versión de este modelo o equipamiento similar - o si su equipamiento existente mide menos de 25 cm - debe devolver los artículos que ya no necesite al su vendedor, el cual contactará con la compañía u organización responsable de la recolección y tratamiento de eliminación adecuado de equipos usados.

Una separación correcta y un tratamiento específico de WEEE son necesarios para evitar un potencial daño a la salud y al medioambiente, y favorece la recuperación y el reciclaje de los materiales.

Una eliminación impropia o ilegal de este producto por el usuario podrá acarrear sanciones o castigos de acuerdo con los Decretos Nacionales basados en la Directiva 91/156/EC y 2008/98/EC.

Gracias por comprar un producto JOBY.

Los productos JOBY están garantizados para el propósito para el cual fueron diseñados y están libres de defectos de materiales y de mano de obra. Esta garantía no cubre el producto contra daños subsecuentes o un mal uso. El período de validez de la Garantía Limitada Convencional está definido por la ley vigente en el país, estado o región donde el producto ha sido vendido. Por favor conserve su recibo como comprobante de compra para reparar su producto bajo garantía.

AVISO LEGAL

A informação contida neste documento pode ser modificada sem pré-aviso.

A Vitec Imaging Solutions não faz qualquer garantia e não pode ser responsabilizada por quaisquer erros de informação contidos neste documento.

Qualquer alteração ou modificação não expressamente aprovada pela Vitec Imaging Solutions pode anular os direitos do utilizador de usar este equipamento.

INFORMAÇÃO PARA OS UTILIZADORES

De acordo com o Artigo 10 da Directiva 2012/19/UE de 04/07/2012 respeitante a resíduos de Equipamentos Eléctricos e Electrónicos (REEE).



O símbolo acima, também representado no equipamento, indica que quando o utilizador decidir desfazer-se do equipamento, NÃO o deve colocar num contentor municipal de lixos domésticos não diferenciados mas num contentor selectivo apropriado. O mesmo se aplica a todos os componentes do equipamento e a quaisquer recargas ou elementos relacionados com o produto.

Para mais informação sobre os sistemas de recolha de lixo indicados para este equipamento, contacte Vitec Imaging Solutions ou qualquer membro autorizado indicado nos Registos Nacionais dos países da União Europeia. Os resíduos domésticos (ou similares) podem ser colocados nos contentores municipais de recolha de resíduos diferenciados.

Se adquirir uma nova versão deste modelo ou equipamento similar - ou se o equipamento que possui actualmente mede menos de 25 cm -, pode devolver os itens de que não necessita ao seu retalhista, que tratará de entrar em contacto com a empresa ou organização responsável pela recolha e gestão de equipamentos usados.

Uma separação correcta e o tratamento REEE são necessários para evitar um potencial perigo para a saúde e o meio ambiente, e favorecer a reciclagem e recuperação dos componentes do equipamento.

A eliminação imprópria ou ilegal deste produto pode acarretar ao utilizador a aplicação de penas e multas de acordo com os decretos nacionais baseados nas Directivas 91/156/EC e 2008/98/EC.

Obrigado por adquirir um produto *JOBY*.

Os produtos *JOBY* são garantidos para cumprirem a finalidade para que foram concebidos, e para se apresentarem livres de defeitos de materiais e mão-de-obra. Esta garantia não cobre o produto contra danos provocados ou uso indevido subsequentes. O prazo de validade da garantia limitada padrão é definido pela lei em vigor no país, estado ou região onde o produto é vendido. Por favor guarde o recibo como prova de compra, para reparar o seu produto ao abrigo da garantia.

FRISKRIVNINGSKLAUSUL

Informationen i detta dokument kan komma att ändras utan föregående meddelande.

Vitec Imaging Solutions ger inga garantier och ska inte hållas ansvariga för eventuella fel i informationen som detta dokument innehåller.

Alla ändringar och modifikationer som inte uttryckligen har godkänts av Vitec Imaging Solutions kan göra användarens behörighet att använda den här utrustningen ogiltig.

INFROMATION FÖR ANVÄNDARE



I enlighet med artikel 10 i direktivet 2012/19/UE från 04 juli 2012 om avfall som utgörs av eller innehåller elektrisk och elektronisk utrustning (WEEE).

 Ovanstående symbol, som även finns på utrustningen, visar att vid den tidpunkt då användaren beslutar sig för att avyttra enheten så får den INTE kasseras som osorterat kommunalt avfall, utan måste samlas in separat. Samma sak gäller alla komponenter i utrustningen och alla laddningsbara eller påfyllningsbara element som produkten kan bestå av.

För information om lämpliga avfallsinsamlingssystem för denna utrustning, kontakta Vitec Imaging Solutions eller en behörig medlem i respektive EU-lands nationella register. Hushållsavfall (eller liknande) kan avyttras via de vanliga kommunala avfallsinsamlingssystemen.

Om du köper en ny version av den här produkten eller motsvarande och om dina befintliga produkter inte längre används samt är mindre än 25 cm så kan du lämna de produkterna till din återförsäljare som i sin tur har ansvar för att kontakta det företag som hanterar den här typen av förbrukade produkter.

Korrekt separat insamling och specifik hantering av WEEE är nödvändig för att undvika eventuell skada på människors och miljöns hälsa och främjar återvinning och återanvändning av komponentmaterial.

Om användaren på felaktigt eller olagligt sätt avyttrar denna produkt kan detta leda till straff eller böter i enlighet med nationella förordningar baserade på direktiven 91/156/EC och 2008/98/EC.

Tack för att du har köpt en JOBY-produkt.

JOBY-är garanterat lämpade för de ändamål de är tillverkade för och är fria från defekter i material och utförande. Denna garanti täcker inte påföljande skador eller felaktig användning av produkten. Giltighetsperioden för den begränsade standardgarantin fastställs av gällande lagar i det land, den stat eller region där produkten säljs. Behåll ditt kvitto som inköpsbevis för reparationen under garantitiden.

DISCLAIMER

De informatie in dit document kan worden gewijzigd zonder berichtgeving.

Vitec Imaging Solutions geeft geen garantie en is niet verantwoordelijk voor foutieve informatie in dit document.

Bij aanpassingen en of modificaties welke niet uitdrukkelijk zijn goedgekeurd door Vitec Imaging Solutions kunnen gebruikers de bevoegdheid verliezen om dit apparaat te bedienen.

INFORMATIE VOOR DE GEBRUIKERS

In overeenstemming met Article 10 of Directive 2012/19/UE of the 04/07/2012 concerning Waste Electrical and Electronic Equipment (WEEE).



Bovenstaand symbool, ook vertegenwoordigd op het apparaat, geeft aan dat indien de gebruiker het product niet meer wenst, dit product niet bij het huishoudelijk afval mag worden aangeboden, maar separaat dient te worden ingeleverd. Dit geldt ook voor alle componenten van het product en enige herlaadbare of hervulbare elementen die het product mogelijk bevat.

Voor meer informatie over het afval scheidingssysteem passend bij dit product, neem contact op met Vitec Imaging Solutions of een andere geautoriseerd lid van de Nationale Registers in de EU landen. Huishoudelijk (of vergelijkbaar) afval mag worden gedeponereerd bij het algemene afval scheidingsstation.

Als u een nieuwe versie van dit model of soortgelijke apparatuur aanschaft, of als uw bestaande apparatuur minder dan 25 cm bedraagt, kunt u de artikelen die u niet meer nodig heeft aan uw retailer retourneren, die zal contact op nemen met het bedrijf of de organisatie die de juiste inzameling en verwerking behandelt van gebruikte apparatuur.

Correcte scheiding en afhandeling van WEEE is nodig om potentiële schade aan de menselijke gezondheid en natuur te voorkomen en ten behoeve van het recyclen van componenten en materialen.

Incorrect of illegaal verwijderen van dit product door de gebruiker zal leiden tot straffen of boetes toegepast volgens de Nationale richtlijnen gebaseerd op Directive 91/156/EC en 2008/98/EC.

Bedankt voor de aankoop van een JOBY product.

JOBY producten zijn gegarandeerd te gebruiken voor het doel waarvoor ze zijn ontworpen, en vrij van defecten in materialen en vakmanschap. Deze garantie is niet van toepassing op de gevolgen van schade en of misbruik van het product. De geldigheidsduur van de Standard Limited Warranty is gedefinieerd in het recht van toepassing in het land, de staat of de regio waar het product is gekocht. Bewaar het aankoopbewijs om het product onder garantie te laten herstellen.

CAYMA HAKKI

Bu belgede belirtilen bilgiler hiçbir uyarı yapılmaksızın değiştirilebilir.

Vitec Imaging Solutions bu belge içinde olabilecek hatalardan sorumlu tutulamaz.

Vitec Imaging Solutions tarafından yazılı olarak belirtilmeden uygulanan değişiklik veya düzenlemeler, kullanıcının bu ürün üzerindeki kullanma hakkını ortadan kaldırır.

KULLANICI İÇİN BİLGİLER

04/07/2012 tarihli 2012/19/AB Elektrikli ve Elektronik Ürünler Atığı Yönergesi Md.10 uyuşturur.

Aşağıda belirtilen ve ürün üzerinde de bulunan bu sembol, kullanıcı ürünü atmaya karar verdiğinde, ürünün kamusal atıklarla beraber ATILAMAYACAĞINI, ayrıştırılması gerektiğini ifade eder. Bu bilgi ürünün içerebileceği şarj ve doldurma aparatları için de geçerlidir.

Bu ürüne uygun atık toplama sistemi ile ilgili bilgi için Vitec Imaging Solutions veya AB ülkeleri ulusal sicilleriyle iletişime geçebilirsiniz. Evsel (veya benzeri) atıklar, yerel atık toplama kurallarına göre işlem görürler.

Eğer bu ürünün yeni modelini yahut benzer bir modelini satın alırsanız,(veya varolan ekipmanınız 25cm'den ufak ölçülerde ise) ihtiyacınız olmayan bu ürünleri verdiğiniz bayilerden geri isteyebilir ya da şirket ile iletişime geçip kullanılmış olan ürünlerin toplatılmasını isteyebilirsiniz.

Doğru ayrıştırma işlemi ve Elektrikli ve Elektronik Ürünler Atığı uygulaması; insan ve çevre sağlığına gelebilecek zararların önlenmesini ve ürünün geri dönüşümünün sağlanmasını amaçlar. Bu ürünün kullanıcı tarafından uygunsuz veya yasal olmayan yöntemlerle atılması cezai sonuç doğurabilir (91/156/EC and 2008/98/EC yönergeler).

JOBY ürününü tercih ettiğiniz için teşekkür ederiz.

JOBY ürünleri, tasarlandıkları amaçlar doğrultusunda kullanılabilirler için, ve malzeme veya işçilikten kaynaklanabilecek olumsuzlukları giderebilmek adına garanti altındadır. Bu garanti, sonradan meydana getirilen zararları veya hatalı kullanımları kapsamaz. Standart sınırlı garanti, ürünün satıldığı ülkenin yasalarında belirtilen süredir. Garantiden faydalanabilmek için lütfen satınalma belgenizi saklayınız.

ОГРАНИЧЕНИЕ ОТВЕТСТВЕННОСТИ

Информация, содержащаяся в этом документе, может изменяться без предварительного уведомления.

Компания Vitec Imaging Solutions не несет ответственности за ошибки, допущенные в этом документе, и не гарантирует их отсутствия.

Любые изменения или модификации, не подтвержденные компанией Vitec Imaging Solutions в явном виде, могут лишить пользователя полномочий использовать данное оборудование.

Благодарим вас за приобретение товара JOBY.

Мы гарантируем, что продукция JOBY соответствует своему назначению и изготовлена из доброкачественных материалов без производственного брака. Гарантия не распространяется на повреждения, возникшие после покупки в результате неправильного использования продукта. Сроки действия Стандартной Ограниченной Гарантии определяются действующим законодательством страны или региона, где была приобретена продукция. Пожалуйста, сохраняйте товарный чек продукта для подтверждения покупки и права на осуществление гарантийного ремонта.

免责声明

该文档中包含的信息在未通知状态下可能发生变更。未泰克影像解决方案事业部对文档中信息的准确性、可靠性不做任何声明或保证。经未泰克影像解决方案事业部明确同意的变更或修改，会有损用户使用该设备的权限。

感谢购买JOBY产品。

JOBY保证所有产品均符合设计目标，没有材质和工艺缺陷。购买后的人为破坏或不当使用，不适用于该保证。标准有限保修的有效期由售出产品所在的国家或地区的相关法律定义。请保留购买收据，在保修期内进行产品维修。

免責聲明

本文檔中的資訊如有變更，恕不另行通知。

對本文檔所含資訊的任何錯誤，Vitec Imaging Solutions不提供任何保證。

未經Vitec Imaging Solutions明確批准的任何改動都可能令使用者失去操作本設備的許可權。

感謝您購買JOBY產品。

JOBY產品確保適用於其設計目的，而無任何材料和工藝缺陷。本保養範圍不包括人為損壞或者因錯誤使用的損毀。標準保養的有效期限將根據此產品銷售的代理商規定，並遵守國家、州或者地區法律規定。請保留您的購買單據以便進行保養。

주의

이 문서에 포함 된 정보는 사전 통보 없이 변경 될 수 있습니다. Vitec Imaging Solutions는 본 문서에 표기된 정보의 오기 및 오류에 대해 어떠한 책임도 지지 않습니다. Vitec Imaging Solutions에서 명시적으로 승인하지 않은 변경이나 개조는 사용자의 장비 사용 권한을 무효로 할 수 있습니다.

JOBY 제품을 구입해 주셔서 감사합니다.

JOBY는 제품의 설계된 목적에 맞춰 사용할 경우, 무상 보증 기간을 제공합니다. 이 보증은 사용자 과실에 의한 손상이나 오용으로 인한 파손을 보증하지 않습니다. 본 제품의 보증 기간은 판매되는 국가, 주 또는 지역의 현행법에 의해 정의됩니다. 또한 보증 서비스를 받기 위해, 구입일이 표시된 영수증을 보관해야 합니다.

免責事項

本書に含まれる情報は、予告なしに変更されることがあります。

ヴァイテックイメージングソリューションズは、この文書に含まれる情報のいかなる誤りに対しても補償責任を負いません。

ヴァイテックイメージングソリューションズによって認められていない変更または修正は、機器の操作についてユーザー権限を無効になることがあります。

JOBY製品をお買い上げいただきありがとうございます。

JOBY製品をお買い上げいただきありがとうございます。

JOBY製品は、その本来の使用目的に適合しており、材料および製造上の瑕疵がないことが保証されています。この保証は、その後の損害または誤用に対して製品を保護するものではありません。標準保証の有効期間は、製品が販売される国、州、または地域で有効な法律によって定義されています。保証の下で製品を修理するため、購入証明として領収書を保管してください。

CERTIFICATIONS
EU



Manufacturer's name :

Vitec Imaging Solutions Spa

Manufacture's address :

Via Valsugana 100, 36022 Cassola (VI), Italy

Product name : Microphone

Product mode : Wavo POD

Simplified Declaration of Conformity

GB - Hereby, "Vitec Imaging Solutions" declares that the radio equipment type "JB01775-BWW" is in compliance with Directive 2014/30/EU and with Directive 2011/65/CE and its amendments.

The full text of the EU declaration of conformity is available at the following internet address:

I - Il fabbricante, "Vitec Imaging Solutions", dichiara che il tipo di apparecchiatura radio "JB01775-BWW" è conforme alle direttiva 2014/30/EU e alla direttiva 2011/65/CE e alle sue rettifiche.

Il testo completo della dichiarazione di conformità UE è disponibile al seguente indirizzo Internet:

D - Hiermit erklärt "Vitec Imaging Solutions", dass der Funkanlagentyp "JB01775-BWW" der Richtlinie 2014/30/EU entspricht und der EU Richtlinie 2011/65/CE und deren Änderungen übereinstimmt.

Der vollständige Text der EU-Konformitätserklärung ist unter der folgenden Internetadresse verfügbar:

F - Le soussigné, "Vitec Imaging Solutions", déclare que l'équipement radioélectrique du type "JB01775-BWW" est conforme à la directive 2014/30/EU et à la directive 2011/65/UE et ses amendements.

Le texte complet de la déclaration UE de conformité est disponible à l'adresse internet suivante:

E - Por la presente, "Vitec Imaging Solutions" declara que el tipo de equipo radioeléctrico "JB01775-BWW" es conforme con la Directiva 2014/30/EU y con la Directiva 2011/65/CE y sus modificaciones.

El texto completo de la declaración UE de conformidad está disponible en la dirección Internet siguiente:

P - O abaixo assinado "Vitec Imaging Solutions" declara que o presente tipo de equipamento de rádio "JB01775-BWW" está em conformidade com a Diretiva 2014/30/EU e com a Diretiva 2011/65/CE e suas respectivas emendas.

O texto integral da declaração de conformidade está disponível no seguinte endereço de Internet:

S - Härmed försäkrar "Vitec Imaging Solutions" att denna typ av radioutrustning "JB01775-BWW" överensstämmer med direktiv 2014/30/EU och direktiv 2011/65/CE och dess tillägg.

Den fullständiga texten till EU-försäkran om överensstämmelse finns på följande webbadress:

NL - Hierbij verklaar ik, "Vitec Imaging Solutions", dat het type radioapparatuur "JB01775-BWW" conform is met Richtlijn 2014/30/EU en Richtlijn 2011/65/UE en de daaraan toe behorende amendementen is.

De volledige tekst van de EU-conformiteitsverklaring kan worden geraadpleegd op het volgende internetadres:

TR - Burada, "Vitec Imaging Solutions", "JB01775-BWW" tipi radyo ekipmanının 2014/30/EU sayılı Direktife uygun olduğunu beyan eder. AB uyumu beyanının tam metni aşağıdaki internet adresinden edinilebilir:

USA

Declaration of conformity

NOTE: This equipment has been tested and found to comply with the limits for a Class B digital device, pursuant to part 15 of the FCC Rules. These limits are designed to provide reasonable protection against harmful interference in a residential installation. This equipment generates, uses and can radiate radio frequency energy and, if not installed and used in accordance with the instructions, may cause harmful interference to radio communications. However, there is no guarantee that interference will not occur in a particular installation. If this equipment does cause harmful interference to radio or television reception, which can be determined by turning the equipment off and on, the user is encouraged to try to correct the interference by one or more of the following measures:

- Reorient or relocate the receiving antenna.
- Increase the separation between the equipment and receiver.
- Connect the equipment into an outlet on a circuit different from that to which the receiver is connected.
- Consult the dealer or an experienced radio/TV technician for help.

This device complies with part 15 of the FCC Rules. Operation is subject to the following two conditions: (1) This device may not cause harmful interference, and (2) this device must accept any interference received, including interference that may cause an undesired operation.

The device has been evaluated to meet general RF exposure requirement. The device can be used in portable exposure condition without restriction.

Any Changes or modifications not expressly approved by the party responsible for compliance could void the user's authority to operate the equipment.

CANADA

IC Statements:

This device complies with Industry Canada licence-exempt RSS standard(s). Operation is subject to the following two conditions: (1) this device may not cause interference, and (2) this device must accept any interference, including interference that may cause undesired operation of the device.

Under Industry Canada regulations, this radio transmitter may only operate using an antenna of a type and maximum (or lesser) gain approved for the transmitter by Industry Canada. To reduce potential radio interference to other users, the antenna type and its gain should be so chosen that the equivalent isotropically radiated power (e.i.r.p.) is not more than that necessary for successful communication.

Déclaration d'IC :

Ce dispositif est conforme aux normes RSS exemptes de licence d'Industrie Canada.

Son fonctionnement est assujéti aux deux conditions suivantes : (1) ce dispositif ne doit pas provoquer de perturbation et (2) ce dispositif doit accepter toute

perturbation, y compris les perturbations qui peuvent entraîner un fonctionnement non désiré du dispositif.

Selon les réglementations d'Industrie Canada, cet émetteur radio ne doit fonctionner qu'avec une antenne d'une typologie spécifique et d'un gain maximum (ou inférieur) approuvé pour l'émetteur par Industrie Canada. Pour réduire les perturbations radioélectriques nuisibles à d'autres utilisateurs, le type d'antenne et son gain doivent être choisis de manière à ce que la puissance isotrope rayonnée équivalente (P.I.R.E.) n'exécède pas les valeurs nécessaires pour obtenir une communication convenable.

RUSSIA – BELARUS - KAZAKHSTAN – KYRGYZSTAN - ARMENIA



AUSTRALIA – NEW ZEALAND



KOREA CERTIFICATION

“B”급 기기

(가정용 방송통신기자재)

Class B Equipment

(For Home Use Broadcasting & Communication Equipment)

이 기기는 가정용(B급) 전자파적합기기로서 주로 가정에서 사용하는 것을 목적으로 하며, 모든 지역에서 사용할 수 있습니다.

This equipment is home use (Class B) electromagnetic wave suitability equipment and to be used mainly at home and it can be used in all areas.

Microphone

Model:Wavo POD

Vitec Imaging Solutions Spa

KCC ID:R-R-Vi6-WavoPOD



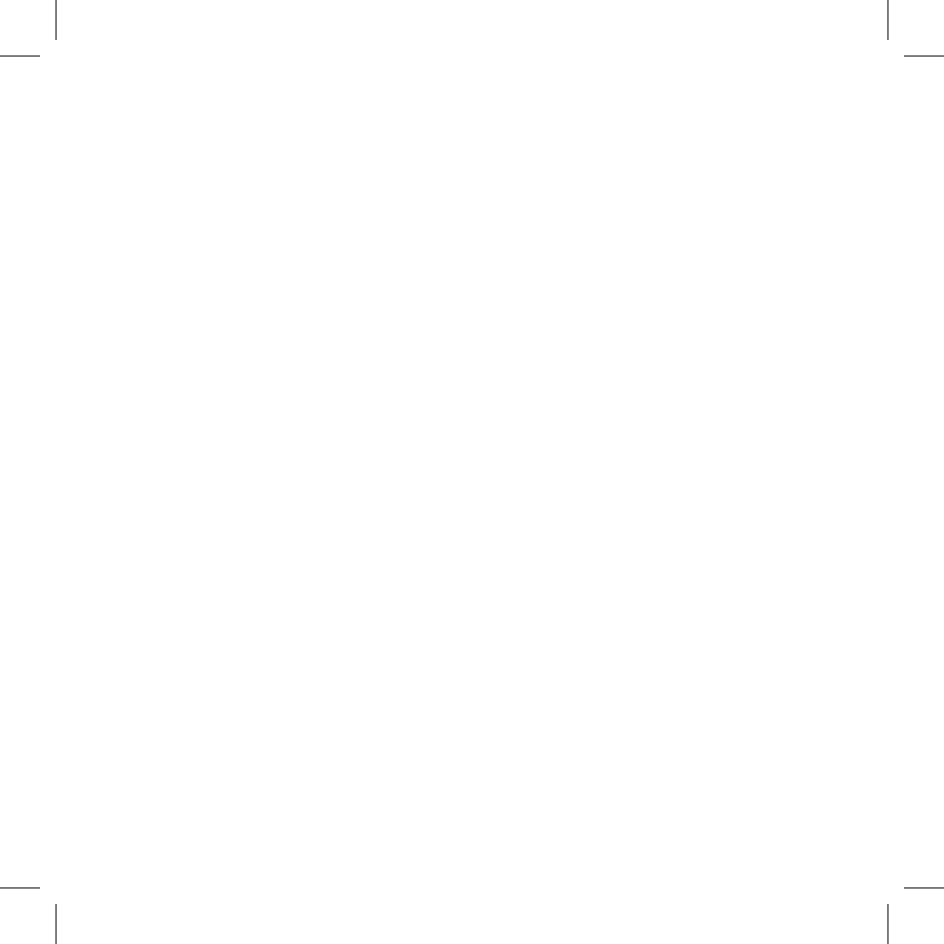

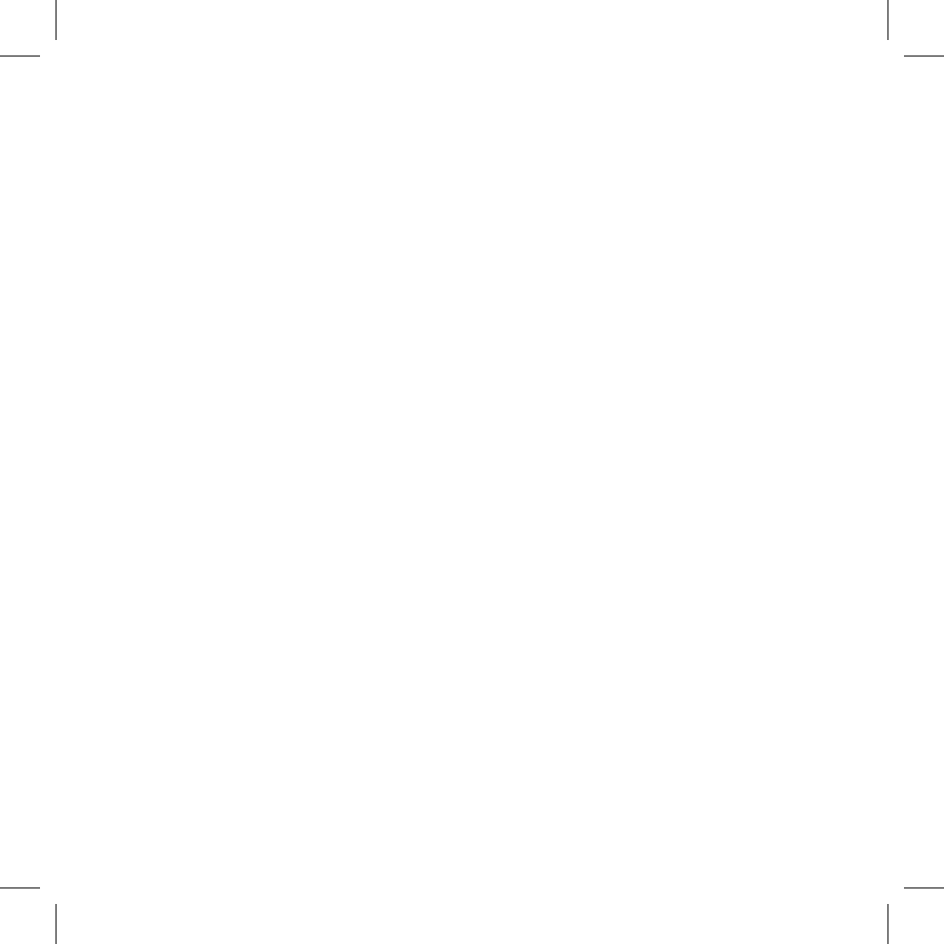

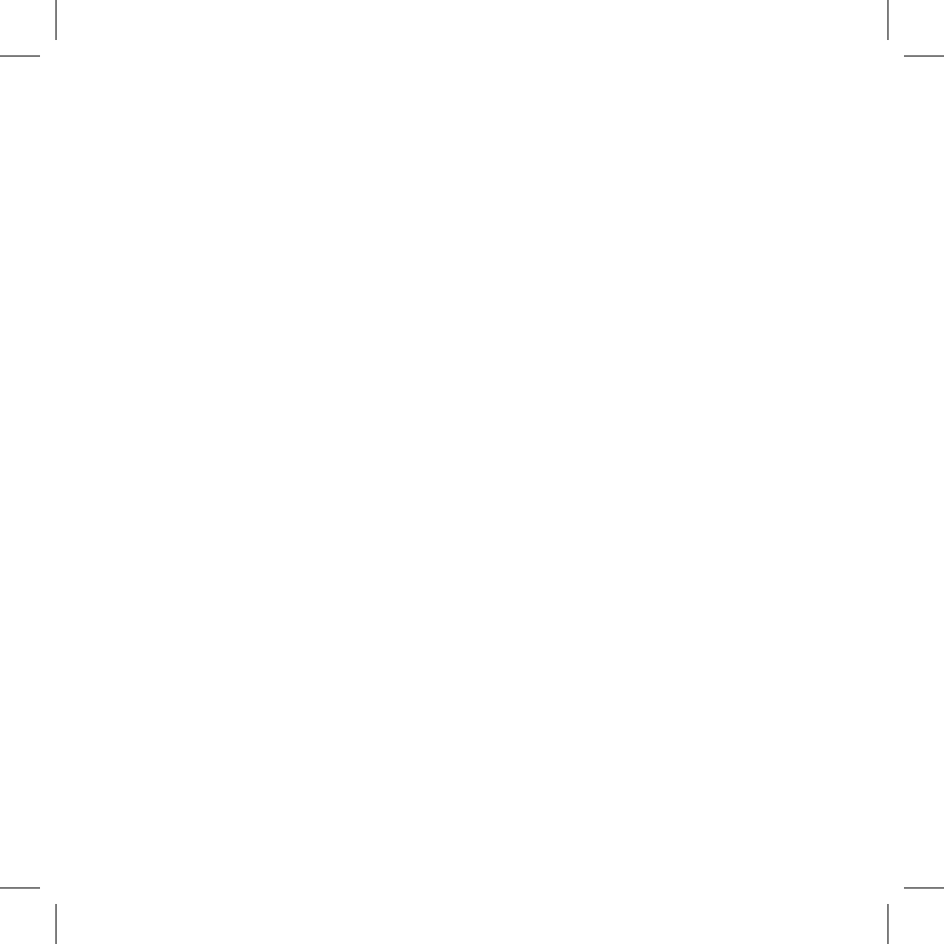



Vitec Imaging Solution Spa
Via Valsugana 100
36022 Cassola (VI) - Italy

© 2021 Vitec Holdings Italia Srl

JOBY is a registered
trademark of
Vitec Holding Italia Srl

Cod. 0500-234 - 08/21